

lighting solutions

CATÁLOGO CATALOG 2026-27

YLD *LIGHTING
MANUFACTURER*
EUROPE®

EDICIÓN ABRIL 2026 APRIL 2026 EDITION

Colaboración con el laboratorio
IMQ TECNOCREA acreditado según ISO 17025

YLD *LIGHTING
MANUFACTURER*
EUROPE®

EVOLUCIÓN EVOLUTION

Tras más de dos décadas de experiencia en el diseño, desarrollo y fabricación de artículos de iluminación técnica y decorativa para marcas líderes del mercado, alrededor del año 2015, iniciamos la fundación de nuestra propia marca comercial. Esta marca se distingue por ofrecer soluciones de iluminación más avanzadas en el mercado y por su constante innovación en este sector: YLD Lighting Manufacturer S.A.

En 2016, YLD comenzó sus operaciones en España como sede central para Europa y un centro logístico estratégico, teniendo como objetivo establecernos en el mercado español y seleccionar cuidadosamente los productos. Desde aquí, iniciamos el proceso de expansión de la marca al mismo tiempo que continuamos con nuestras operaciones de fabricación personalizada para diversas marcas, tanto a nivel nacional como internacional.

Durante estos años, hemos participado en numerosas ferias nacionales e internacionales, destacando nuestra presencia en eventos clave como Matelec Madrid, Habitat Valencia, Construmat Barcelona, Lighting Days Lyon, Rebuild Madrid, Light + Building Frankfurt, y en las prestigiosas Building Technology Guangzhou y Light + Building Hong Kong. Este constante compromiso nos ha permitido consolidar la marca YLD en España y en parte de Europa, siendo reconocidos por la calidad, fiabilidad y atención excepcional que ofrecemos a nuestros clientes.

Nuestro objetivo de implantación a nivel internacional sigue su curso y confiamos en seguir forjando alianzas decisivas con distribuidores oficiales de la firma, además de abrir nuevas delegaciones propias en aquellos países donde la firma busca establecerse.

Continuamos avanzando en la evolución de nuestra línea de productos, ampliando nuestras capacidades de producción en iluminación técnica, decorativa, industrial y vial. Utilizamos exclusivamente componentes de las marcas más respetadas en el mercado, garantizando así la calidad de nuestros productos. Además, mantenemos un compromiso constante con la mejora de nuestros procesos de investigación, desarrollo, innovación, producción, logística y distribución.

En YLD, nuestra dedicación hacia la excelencia y la satisfacción del cliente nos impulsa a seguir adelante con determinación y pasión, siempre con la mirada puesta en el futuro y en ofrecer soluciones de iluminación de vanguardia.

After more than two decades of experience in the design, development, and manufacturing of technical and decorative lighting fixtures for leading brands in the market, around the year 2015, we began laying the groundwork for our own commercial brand. This brand is distinguished by offering more advanced lighting solutions in the market and by its constant innovation in this sector: YLD Lighting Manufacturer S.A.

In 2016, YLD began its operations in Spain as the headquarters for Europe and a strategic logistics center, aiming to establish ourselves in the Spanish market and carefully select products. From here, we initiated the brand expansion process while continuing our custom manufacturing operations for various brands, both nationally and internationally.

During these years, we have participated in numerous national and international fairs, highlighting our presence at key events such as Matelec Madrid, Habitat Valencia, Construmat Barcelona, Lighting Days Lyon, Rebuild Madrid, Light + Building Frankfurt, and prestigious events like Building Technology Guangzhou and Light + Building Hong Kong. This constant commitment has allowed us to consolidate the YLD brand in Spain and parts of Europe, recognized for the quality, reliability, and exceptional service we offer to our customers.

Our international implementation objective is progressing, and we trust in continuing to forge decisive partnerships with official distributors of the firm, as well as opening new own branches in those countries where the firm seeks to establish itself.

We continue to advance in the evolution of our product line, expanding our production capabilities in technical, decorative, industrial, and street lighting. We exclusively use components from the most respected brands in the market, thus ensuring the quality of our products. Additionally, we maintain a constant commitment to improving our processes of research, development, innovation, production, logistics, and distribution.

At YLD, our dedication to excellence and customer satisfaction drives us to move forward with determination and passion, always with an eye on the future and offering cutting-edge lighting solutions.

LA TEMPERATURA DE COLOR

La temperatura de color se refiere a la predominancia de ciertos colores del espectro lumínico en la luz blanca, lo que puede modificarla hacia tonos cálidos, como el amarillo-anaranjado, o hacia tonos fríos, como el azul. Se mide en grados Kelvin.

En el ámbito de la iluminación LED, se destacan diversas dominantes de color, que van desde tonalidades anaranjadas hasta azules, clasificándolas en tres categorías diferentes: luz cálida, luz blanca y luz fría. Mientras que los tonos cálidos evocan sensaciones de confort, relajación y calidez, los tonos blancos y fríos sugieren dinamismo, limpieza y frescura, entre otras cualidades. Los tonos blancos son los más similares a la luz natural.



LUZ CÁLIDA
2.500 - 3.500K

LUZ BLANCA
4.000 - 5.500K

LUZ FRÍA
5.800 - 6.500K

CONCEPTOS ASOCIADOS

- CONFORT
- RELAX
- AMISTOSO
- ÍNTIMO
- PERSONAL
- EXCLUSIVO
- LUJO

CONCEPTOS ASOCIADOS

- FRESCOR
- EFICIENTE
- LIMPIEZA
- PRODUCTIVO
- FRUCTÍFERO
- HIGIENE
- PULCRITUD

CONCEPTOS ASOCIADOS

- EFICACIA
- DINÁMICO
- RAPIDEZ
- HIGIENE
- ACTIVO
- ENERGÍA
- AGILIDAD

EJEMPLOS PARA UNA BUENA ELECCIÓN DE LA TEMPERATURA DE COLOR

APLICACIONES	LUZ CÁLIDA	LUZ BLANCA	LUZ FRÍA
VIVIENDAS			
NEGOCIOS			
OFICINAS			
SALAS DE CONFERENCIA			
RESTAURANTES			
HOTELES			
RECEPCIONES			
SALONES			
CAFETERÍAS			
BOUTIQUES			
ESCUELAS			
UNIVERSIDADES			
HOSPITALES			
INDUSTRIA			
CONSULTORIOS MÉDICOS			
REST. DE COMIDA RÁPIDA			
FLORISTERÍA			
EXPOSICIONES			
JOYERÍA			
PELUQUERÍA-ESTÉTICA			
SUPERMERCADOS			
ALIMENTACIÓN			
TEXTIL			
MOBILIARIO			

GRADOS DE PROTECCIÓN IP

La normativa conocida como International Protection o IP se emplea para establecer los niveles de protección de los productos LED.

Esta normativa, y por ende, la numeración IP, debe aparecer siempre en este tipo de productos para indicar su grado de protección contra agentes externos, ya sean líquidos o sólidos.

Los grados de protección IP determinan lo siguiente:

- Protección para las personas.
- Protección para los dispositivos de iluminación y equipos eléctricos contra la entrada de objetos sólidos, como el polvo.
- Protección para las instalaciones de luz contra los efectos dañinos del agua.

Por lo general, estos productos deben operar de forma segura durante largos períodos y en condiciones ambientales adversas. Por eso, es fundamental establecer una codificación para identificar cuál producto es el más adecuado para cada instalación.

La normativa establece la siguiente codificación:

Un código IP consta de las letras "IP" seguidas de dos dígitos. El primer dígito varía del 0 al 6 y el segundo, del 0 al 9.

- Las letras "IP" identifican el estándar (del inglés: International Protection).

- El valor del primer dígito indica el nivel de protección contra el polvo.

- El valor del segundo dígito indica el nivel de protección contra líquidos, generalmente agua.

Como regla general, se puede afirmar que a mayor grado de protección IP, mayor es la protección del equipo.

PRIMER DÍGITO. PROTECCIÓN IP CONTRA OBJETOS Y SUCIEDAD

- | | |
|---|---|
| 0 | Sin protección contra el contacto, sin protección contra cuerpos extraños |
| 1 | Protección contra cuerpos extraños con diámetro >50mm |
| 2 | Protección contra cuerpos extraños con diámetro >12mm |
| 3 | Protección contra cuerpos extraños con diámetro >2,5mm |
| 4 | Protección contra cuerpos extraños con diámetro >1mm |
| 5 | Protección completa contra contacto, protección contra sedimentaciones de polvos en el interior |
| 6 | Protección completa contra contacto, protección contra penetración de polvo |

SEGUNDO DÍGITO. PROTECCIÓN IP CONTRA AGUA Y HUMEDAD

- | | |
|---|--|
| 0 | Sin protección contra agua |
| 1 | Protegido contra gotas de agua que caen verticalmente |
| 2 | Protegido contra gotas de agua que caen inclinado (15° respecto de la vertical) |
| 3 | Protegido contra agua pulverizada (hasta 60° respecto de la vertical) |
| 4 | Protegido contra agua pulverizada |
| 5 | Protegido contra los chorros de agua (desde todas las direcciones) |
| 6 | Protegido contra la penetración de agua en caso de inyección pasajera |
| 7 | Protegido contra la penetración de agua sumergiéndolo |
| 8 | Protegido contra la penetración de agua sumergiéndolo por un período indefinido |
| 9 | Protegido contra la penetración de agua de todas direcciones también en caso de una presión alta contra el chasis. (limpiadora de alta presión o de chorro de vapor, 80-100 bar) |



IP21: Protección contra cuerpos extraños con diámetro >12mm y protegido contra gotas de agua que caen verticalmente

ACABADOS FINISHES



BK
NEGRO GRAFITO
GRAPHITE BLACK



BR
CROMO SATINADO
SATIN CHROME



CH
CROMO BRILLO
BRIGHT CHROME



G
DORADO
GOLD



SN
NÍQUEL SATINADO
SATIN NICKEL



P
BRONCE
BRONZE



Q
COBRE VIEJO
OLD COPPER



W
BLANCO
WHITE



RC
COBRE BRILLANTE
BRIGHT COPPER



FBK
NEGRO TEXTURIZADO
TEXTURIZED BLACK



FW
BLANCO TEXTURIZADO
TEXTURIZED WHITE



PL
PLATA TEXTURIZADO
TEXTURIZED SILVER



A
CRISTAL
GLASS



F
CRISTAL TRANSLÚCIDO
TRANSLUCENT GLASS















































BU
ALUMINIO CEPILLADO
BRUSHED ALUMINIUM



GY
GRIS PLOMO
LEAD GREY

SIMBOLOGÍA SYMBOLOGY

 30.000h	 ON/OFF x 10.000	 AC 220V 240V	 Hz 50/60	 NO DIMMABLE	 DIMMABLE	 RoHS COMPLIANT
VIDA ÚTIL LIFESPAN	CICLOS ON/OFF ON/OFF CYCLES	TENSIÓN IMPULS VOLTAGE	FRECUENCIA FREQUENCY	NO REGULABLE NON DIMMABLE	REGULABLE DIMMABLE	ROHS APROBADO ROHS APPROVED
						
CE APROBADO CE APPROVED	REGULABLE 0-10V 0-10V DIMMABLE	REGULABLE TRIAC TRIAC DIMMABLE	REGULABLE DALI DALI DIMMABLE	TÜV RHEINLAND APROBADO TUV RHEINLAND APPROVED	PROTECCIÓN PROTECTION	ÍNDICE REPRODUCCIÓN ROMÁTICA CHROMATIC REPRODUCTION INDEX
2.700°K	3.000°K	4.000°K	5.000°K	6.000°K	6.500°K	FRESH
LUZ CÁLIDA 2700K WARM LIGHT 2700K	LUZ CÁLIDA 3000K WARM LIGHT 3000K	LUZ NATURAL 4000K NATURAL LIGHT 4000K	LUZ NATURAL 5000K NATURAL LIGHT 5000K	LUZ FRÍA 6000K COLD LIGHT 6000K	LUZ FRÍA 6500K COLD LIGHT 6500K	LUZ ESPECIAL PARA CÁRNICOS SPECIAL LIGHT FOR MEAT PRODUCTS
						
ÍNDICE DE PROTECCIÓN IK IK PROTECTION INDEX	FACTOR DE POTENCIA POWER FACTOR	CLASE 1 CLASS 1	CLASE 2 CLASS 2	CLASE 3 CLASS 3	POTENCIA POWER	FLUJO LUMINOSO LUMINOUS FLUX
						
ÁNGULO DE APERTURA BEAM ANGLE	ORIENTABLE ADJUSTABLE	DIÁMETRO DE CORTE CUTTING DIAMETER	UNIDADES POR CAJA UNITS PER BOX	SIN PARPADEO NO FLICKERING	NO REGULABLE AC AC NO DIMMABLE	DEGRADACIÓN DEGRADATION
						
PASOS MACADAM MACADAM STEP	ALUMINIO ALUMINIUM	VIDRIO GLASS	SIN LÁMPARA WITHOUT LAMP	CASQUILLO GU10 INCLUIDO UNIFIED GU10 SOCKET INCLUDED	ÍNDICE DE DESLUMBRAMIENTO UNIFIED GLARE RATING	CHIP CHIP
						
ANCHO TIRA LED LED STRIP WIDTH	NÚMERO DE LEDS NUMBER OF LEDS	LARGO TIRA LED LONG LED STRIP	TEMPERATURA DE TRABAJO WORKING TEMPERATURE	CONTROL REMOTO REMOTE CONTROL	CONTROL REMOTO RGB RGB REMOTE CONTROL	SENSOR DE MOVIMIENTO MOTION SENSOR
						
SELECTOR CCT CCT SELECTOR	CASQUILLO GU10 INCLUIDO GU10 CAP INCLUDED					

ÍNDICE DE PRODUCTOS PRODUCT INDEX

1. **PROYECTORES DE CARRIL/** **38.** **TRACK SPOTLIGHTS**

SERIES LC3251 **40.**



SERIES LC3302 **44.**



SERIES LC3303 **48.**



SERIES LC1562 **52.**



SERIES LC3144 SPECIAL RETAIL **54.**



SERIES LC068 - PRECISIÓN LIGHT **56.**

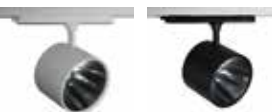

SERIES R004 - MONOFÁSICO

58.



SERIES NC2189 - GU10

59.



CARRILES Y ACCESORIOS ON/OFF - DALI

60.



2.

68.

MÓDULOS LED

LED LIGHT MODULES

SERIES YLD-220V - ALTO CRI

70.



SERIES NC2116 - ACCESORIOS YLD-220V

74.



SERIES NC2119 - ACCESORIOS YLD-220V

76.



SERIES NC2118 - ACCESORIOS YLD-220V

78.



SERIES NC2138 - ACCESORIOS YLD-220V

80.



SERIES NC2156 - ACCESORIOS YLD-220V

82.



SERIES LD607

84.



SERIES LD641 - ACCESORIOS LD607

86.



SERIES LD627/LD607 - ACCESORIOS LD607

88.



SERIES YLD-222

90.



SERIES YLD-223 - CCT

92.



3.

94.

DOWNLIGHT DE EMPOTRAR
RECESSED LED DOWNLIGHT

SERIES LD361

96.



SERIES LF152

98.



SERIES LC505

100.



SERIES KED743

102.



SERIES MINI CCT

112.



SERIES MINI RING

114.

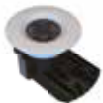

SERIES SMALL CUT

116.



SERIES SMALL CUT - TRIMLESS

120.



SERIES MINIMALIST

124.



SERIES MINIMALIST - TRIMLESS

128.



SERIES ULTRA - NARROW BEAM

132.



SERIES FOCUS ZOOM

136.



SERIES ORBITA UGR

140.



SERIES INTEGRA EMPOTRABLE

146.



SERIES INTEGRA ORIENTABLE

150.



SERIES INTEGRA TRIMLESS

154.



SERIES LC013

158.



SERIES LC1428

162.



SERIES LC1431

164.



SERIES LC3193

166.



SERIES LC1444

167.



SERIES LC1445

168.



SERIES LC1452

169.



SERIES LC1427

170.



SERIES LC1483

174.



SERIES LC1453

177.



SERIES BASIC CCT

178.



SERIES PANEL LED

180.



4.

182.

DOWNLIGHT DE SUPERFICIE

DOWNLIGHT SURFACE

SERIES LC1400

184.



SERIES LC1312

185.



SERIES BASIC CCT

186.



5.

LÁMPARAS SERIES LC

LC SERIES LAMPS

188.

SERIES LC1282

190.



SERIES LC1283

192.



SERIES LC1284

194.



SERIES LC1285

196.



6.

198.

SERIES NC GU10

NC GU10 SERIES

SERIES NC1800-M - SUPERFICIE

200.



SERIES NC1801-M - SUPERFICIE

201.



SERIES NC2156 - EMPOTRABLE

202.



SERIES NC2187 - SUPERFICIE

203.



SERIES NC2188 - COLGANTE

204.

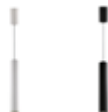

SERIES NC1936 - SUPERFICIE

205.



SERIES NC1942 - SUPERFICIE / SERIES NC1942-80 - SUPERFICIE

206.



SERIES NC1949 - COLGANTE

208.



SERIES NC1955 - COLGANTE

209.



SERIES NC1968 - SUPERFICIE

210.



SERIES NC1962 - SUPERFICIE

211.



SERIES NC1746 - WALL LIGHT

212.



SERIES NC1747 - SUPERFICIE

213.



SERIES NC1464-R95 - SUPERFICIE REDONDO

214.



SERIES NC1464-SQ95 - SUPERFICIE CUADRADO

215.



7.1.

AROS DE ALUMINIO TECH

TECH ALUMINIUM RECESSED RINGS

216.

SERIE CONFORT

218.



SERIE CONFORT ORIENTABLE

220.



SERIE ALA ANCHA

222.



SERIE LUXA

224.



7.2.

226.

AROS DE ALUMINIO DECO

DECO ALUMINIUM RINGS

SERIE NC1860

228.



SERIE NC1855-S

230.



SERIE NC1855-B

232.



SERIE NC2002

234.



SERIE NC1761

236.



SERIE NC1772

238.



SERIE NC1765

240.



SERIE NC1760

242.



SERIE NC1765

244.



SERIE NC1825-M

246.



7.3.

AROS DE ALUMINIO ECO PLUS

ECO PLUS ALUMINIUM RINGS

248.

SERIE NC3014

250.



SERIE NC1301

252.



SERIE NC1302

254.



8.
PLAFONES
CEILING LIGHTS

256.

PLAFONES LED PC CCT IP54

258.



PLAFONES LED PC IP54 XL

259.



PLAFONES LED ECO CCT IP65

260.



PLAFONES LED CCT IP65

262.



APLIQUE LED CUADRADO IP65

264.



APLIQUE LED ALUMINIO IP65

265.



PLAFONES LED PC SENSOR E27X2

266.



9.

268.

APLIQUES

WALL LIGHTS

SERIES LC452 - EMPOTRABLE

270.



SERIES LC447 - SUPERFICIE

271.



SERIES LC454 - SUPERFICIE

272.



SERIES LC073

273.



10.
TIRAS LED
LED STRIPS

274.

LED MONOCOLOR 2835 TOP SERIES - 4,8W - IP20

276.



LED MONOCOLOR 2835 TOP SERIES - 4,8W - IP65

276.



LED MONOCOLOR 2835 TOP SERIES - 9,6W - IP20

276.



LED MONOCOLOR 2835 TOP SERIES - 9,6W - IP65

277.



LED MONOCOLOR 2835 TOP SERIES - 14,4W - IP20

277.



LED MONOCOLOR 2835 TOP SERIES - 14,4W - IP65

277.



LED MONOCOLOR 2835 TOP SERIES - 19,2W - IP20

278.



LED MONOCOLOR 2835 TOP SERIES - 19,2W - IP65

278.



LED MONOCOLOR HIGH PERFORMANCE - 11W - IP20

278.



LED RGB SERIES - RGB+WHITE 22W - IP20

279.



LED RGB SERIES - RGB+WW+CW - 20W - IP20

279.



LED CCT SERIES - 21W - IP20

279.



LED COB SERIES - 5W - IP20

280.



LED COB SERIES - 10W - IP20

280.



LED COB SERIES - 11W - IP20

280.



LED COB SERIES - 18W - IP20

281.



LED DOA 220V SERIES - 8W - IP65

281.



ACCESORIOS TIRAS DE LED

281.

11.
FUENTES DE ALIMENTACIÓN
POWER SUPPLY

282.

FUENTE DE ALIMENTACIÓN 24V KGP COMPACT IP20/ IP67

284.



FUENTE DE ALIMENTACIÓN 24V KGP COMPACT IP67

285.



FUENTE DE ALIMENTACIÓN 24V YLD IP20

285.



FUENTE DE ALIMENTACIÓN 24V INFINITUM REGULABLES TRIAC IP20

286.



FUENTE DE ALIMENTACIÓN 24V MEANWELL REGULABLES 0-10V IP67

286.



FUENTE DE ALIMENTACIÓN 24V EAGLERISE REGULABLES DALI/PUSH IP20

287.



FUENTE DE ALIMENTACIÓN 24V EAGLERISE REGULABLES DALI/PUSH IP20

287.



12.
CONTROLADORES
LED CONTROLLER

288.

CONTROLADORES

290.



MANDOS DE TIRA LED

290.



13.
PERFILERÍA DE ALUMINIO
PROFILE ALUMINUM

292.

PERFILES RODAPIÉ

294.



PERFILES ESQUINA

295.



PERFILES CILÍNDRICOS

297.



PERFILES MUEBLES

298.



PERFILES PARED

299.



PERFILES SUELO

300.



PERFILES ESCALERAS

301.



PERFILES ARQUITECTÓNICOS

302.



PERFILES COLGABLES

304.



PERFILES EMPOTRABLES

308.



PERFILES SUPERFICIE

313.



PERFILES SENCILLOS

319.



PERFILES FLEXIBLES PARA NEÓN

320.



MUESTRARIO DE PERFILES DE ALUMINIO

320.



ACCESORIOS PARA PERFILES: DIFUSORES ESPECIALES

321.



ACCESORIOS PARA PERFILES: DIFUSORES

322.



ACCESORIOS PARA PERFILES: DIFUSORES/COLORES

323.



ACCESORIOS PARA PERFILES: CONECTAR/COLGAR

324.



ACCESORIOS PARA PERFILES: PINZAS/MUEBLES

325.



14.
SOLAR
SOLAR

326.

SERIES ALUMINIUM SOLAR FLOOD LIGHT

328.



SERIES INTEGRATED SOLAR STREET LIGHT

330.



SERIES INTEGRATED SOLAR STREET LIGHT

332.



SERIES LED SOLAR WALL LIGHT

334.



15.
INDUSTRIAL
INDUSTRIAL

336.

SERIES UFO MAX - ALTO RENDIMIENTO

338.



SERIES UFO CCT MULTIPOWER

340.



SERIES UFO PRO

342.



SERIES PROYECTOR ECO CCT

344.



SERIES PANTALLA ESTANCA

346.



16.

348.

BOMBILLAS Y GU10

LED BULBS & GU10

GU10 DIMMABLE/ALUMINIO/ USO PROFESIONAL

350.



GU10 3CCT BOX

351.



GU10 120° BOX

352.



GU10 38° BOX

353.



ESFÉRICA G45 - E27

354.



ESFÉRICA P45 - E14

355.



ESTÁNDAR E27

356.



1.

**PROYECTORES
DE CARRIL**
TRACK
SPOTLIGHTS

SERIES LC3251



Al **20W** **30W** **2.700°K** **3.000°K** **4.000°K** **5.700°K** **AC** **220V** **240V** **50.000h** **10°** **25°** **38°** **60°** **Hz** **50/60**

PF **>0.9** **IP** **20** **RATED** **CRI** **>90** **UGR** **<21** **MACADAM** **<3** **NO FLICKERING** **RoHS** **COMPLIANT** **CE** **5 AÑOS** **GARANTÍA** **KGP** **BRIDGELUX**

DIMENSIONES DIMENSIONS

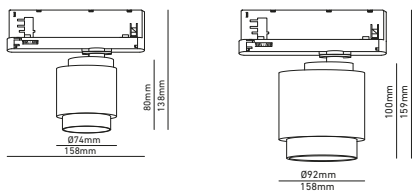

FOTOMETRÍA PHOTOMETRY



ACABADOS FINISHES



REGULACIÓN DIMMING

TRIAC - 0-10V - DALI

* CASAMBI A CONSULTAR

ACCESORIOS ACCESSORIES



SERIES LC3251 - 20W

REF.	POW.	ACABADO	CCT	LM	ANG.	CRI	IP	P.V.P.
039760	20W	FW	2700K	1800	38°	>90	20	58,95 €
036622	20W	FW	3000K	1800	38°	>90	20	58,95 €
036639	20W	FW	4000K	1800	38°	>90	20	58,95 €
039777	20W	FBK	2700K	1800	38°	>90	20	58,95 €
036646	20W	FBK	3000K	1800	38°	>90	20	58,95 €
036653	20W	FBK	4000K	1800	38°	>90	20	58,95 €

REGULACIONES/DIMMING

REF.	POW.	ACABADO	CCT	LM	ANG.	CRI	IP	P.V.P.
TRIAC								
039760-T	20W	FW	2700K	1800	38°	>90	20	93,33 €
036622-T	20W	FW	3000K	1800	38°	>90	20	93,33 €
036639-T	20W	FW	4000K	1800	38°	>90	20	93,33 €
039777-T	20W	FBK	2700K	1800	38°	>90	20	93,33 €
036646-T	20W	FBK	3000K	1800	38°	>90	20	93,33 €
036653-T	20W	FBK	4000K	1800	38°	>90	20	93,33 €
DALI/PUSH								
039760-D	20W	FW	2700K	1800	38°	>90	20	93,33 €
036622-D	20W	FW	3000K	1800	38°	>90	20	93,33 €
036639-D	20W	FW	4000K	1800	38°	>90	20	93,33 €
039777-D	20W	FBK	2700K	1800	38°	>90	20	93,33 €
036646-D	20W	FBK	3000K	1800	38°	>90	20	93,33 €
036653-D	20W	FBK	4000K	1800	38°	>90	20	93,33 €

SERIES LC3251 - 30W

REF.	POW.	ACABADO	CCT	LM	ANG.	CRI	IP	P.V.P.
039784	30W	FW	2700K	2700	38°	>90	20	70,65 €
036806	30W	FW	3000K	2700	38°	>90	20	70,65 €
036813	30W	FW	4000K	2700	38°	>90	20	70,65 €
037971	30W	FW	5700K	2700	38°	>90	20	70,65 €
039791	30W	FBK	2700K	2700	38°	>90	20	70,65 €
036820	30W	FBK	3000K	2700	38°	>90	20	70,65 €
036837	30W	FBK	4000K	2700	38°	>90	20	70,65 €
038398	30W	FBK	5700K	2700	38°	>90	20	70,65 €

REGULACIONES/DIMMING

REF.	POW.	ACABADO	CCT	LM	ANG.	CRI	IP	P.V.P.
TRIAC								
039784-T	30W	FW	2700K	2700	38°	>90	20	105,65 €
036806-T	30W	FW	3000K	2700	38°	>90	20	105,65 €
036813-T	30W	FW	4000K	2700	38°	>90	20	105,65 €
037971-T	30W	FW	5700K	2700	38°	>90	20	105,65 €
039791-T	30W	FBK	2700K	2700	38°	>90	20	105,65 €
036820-T	30W	FBK	3000K	2700	38°	>90	20	105,65 €
036837-T	30W	FBK	4000K	2700	38°	>90	20	105,65 €
038398-T	30W	FBK	5700K	2700	38°	>90	20	105,65 €
DALI								
039784-D	30W	FW	2700K	2700	38°	>90	20	105,03 €
036806-D	30W	FW	3000K	2700	38°	>90	20	105,03 €
036813-D	30W	FW	4000K	2700	38°	>90	20	105,03 €
037971-D	30W	FW	5700K	2700	38°	>90	20	105,03 €
039791-D	30W	FBK	2700K	2700	38°	>90	20	105,03 €
036820-D	30W	FBK	3000K	2700	38°	>90	20	105,03 €
036837-D	30W	FBK	4000K	2700	38°	>90	20	105,03 €
038398-D	30W	FBK	5700K	2700	38°	>90	20	105,03 €

SERIES LC3251 - 20W

ACCESORIOS/ACCESSORIES

REF.	DESCRIPCIÓN	P.V.P.
036660	RC-20W-BODY	6,75 €
036677	RC-20W-RING	2,40 €
036684	CH-20W-BODY	6,75 €
036691	CH-20W-RING	2,40 €
036707	G-20W-BODY	6,75 €
036714	G-20W-RING	2,40 €
036721	BK-20W-BODY	6,75 €
036738	BK-20W-RING	2,40 €
036745	BU-20W-BODY	6,75 €
036752	BU-20W-RING	2,40 €
036769	FW-20W-BODY	5,05 €
036776	FBK-20W-BODY	5,05 €

ÓPTICAS/OPTICS

REF.	DESCRIPCIÓN	P.V.P.
036783	LENS 20W-10°	5,15 €
037094	LENS 20W-25°	5,15 €
036790	LENS 20W-60°	5,15 €

SERIES LC3251 - 30W

ACCESORIOS/ACCESSORIES

REF.	DESCRIPCIÓN	P.V.P.
036844	RC-30W-BODY	9,25 €
036851	RC-30W-RING	3,70 €
036868	CH-30W-BODY	9,25 €
036875	CH-30W-RING	3,70 €
036882	G-30W-BODY	9,25 €
036899	G-30W-RING	3,70 €
037001	BK-30W-BODY	9,25 €
037018	BK-30W-RING	3,70 €
037025	BU-30W-BODY	9,25 €
037032	BU-30W-RING	3,70 €
037049	FW-30W-BODY	6,30 €
037056	FBK-30W-BODY	6,30 €

ÓPTICAS/OPTICS

REF.	DESCRIPCIÓN	P.V.P.
037063	LENS 30W-10°	5,15 €
037117	LENS 30W-25°	5,15 €
037070	LENS 30W-60°	5,15 €

SERIES LC3302



Al 10W 20W 30W 2.700°K 3.000°K 4.000°K AC 220V 240V 50.000h 15° 38° 55° Hz 50/60 PF >0.9 IP 20 RATED
 CRI >90 UGR <21 360° MACADAM <3 NO FLICKERING RoHS COMPLIANT CE 5 AÑOS GARANTÍA **KGP CREE**

DIMENSIONES DIMENSIONS

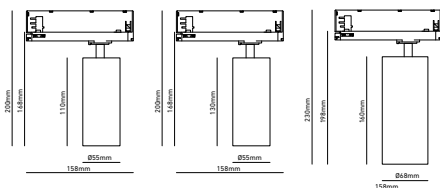

ACABADOS FINISHES



FOTOMETRÍA PHOTOMETRY

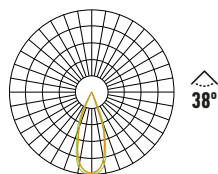

REGULACIÓN DIMMING

TRIAC - 0-10V - DALI

* CASAMBI A CONSULTAR

SERIES LC3302 - 10W

REF.	POW.	ACABADO	CCT	LM	ANG.	CRI	IP	P.V.P.
039807	10W	FW	2700K	1000	38°	>90	20	37,90 €
039814	10W	FW	3000K	1000	38°	>90	20	37,90 €
042869	10W	FW	4000K	1000	38°	>90	20	37,90 €
042876	10W	FBK	2700K	1000	38°	>90	20	37,90 €
042883	10W	FBK	3000K	1000	38°	>90	20	37,90 €
039821	10W	FBK	4000K	1000	38°	>90	20	37,90 €

REGULACIONES/DIMMING

REF.	POW.	ACABADO	CCT	LM	ANG.	CRI	IP	P.V.P.
TRIAC								
039807-T	10W	FW	2700K	1000	38°	>90	20	72,90 €
039814-T	10W	FW	3000K	1000	38°	>90	20	72,90 €
042869-T	10W	FW	4000K	1000	38°	>90	20	72,90 €
042876-T	10W	FBK	2700K	1000	38°	>90	20	72,90 €
042883-T	10W	FBK	3000K	1000	38°	>90	20	72,90 €
039821-T	10W	FBK	4000K	1000	38°	>90	20	72,90 €
DALI/PUSH								
039807-D	10W	FW	2700K	1000	38°	>90	20	72,90 €
039814-D	10W	FW	3000K	1000	38°	>90	20	72,90 €
042869-D	10W	FW	4000K	1000	38°	>90	20	72,90 €
042876-D	10W	FBK	2700K	1000	38°	>90	20	72,90 €
042883-D	10W	FBK	3000K	1000	38°	>90	20	72,90 €
039821-D	10W	FBK	4000K	1000	38°	>90	20	72,90 €

ACCESORIOS/ACCESSORIES

REF.	DESCRIPCIÓN	P.V.P.
------	-------------	--------

ÓPTICAS/OPTICS

REF.	DESCRIPCIÓN	P.V.P.
023462	REFLECTOR 10W-15°	5,15 €
023479	REFLECTOR 10W-55°	5,15 €

SERIES LC3302 - 20W

REF.	POW.	ACABADO	CCT	LM	ANG.	CRI	IP	P.V.P.
039838	20W	FW	2700K	2000	38°	>90	20	56,36 €
038084	20W	FW	3000K	2000	38°	>90	20	56,36 €
038091	20W	FW	4000K	2000	38°	>90	20	56,36 €
039845	20W	FBK	2700K	2000	38°	>90	20	56,36 €
038107	20W	FBK	3000K	2000	38°	>90	20	56,36 €
038114	20W	FBK	4000K	2000	38°	>90	20	56,36 €

REGULACIONES/DIMMING

REF.	POW.	ACABADO	CCT	LM	ANG.	CRI	IP	P.V.P.
TRIAC								
039838-T	20W	FW	2700K	2000	38°	>90	20	91,36 €
038084-T	20W	FW	3000K	2000	38°	>90	20	91,36 €
038091-T	20W	FW	4000K	2000	38°	>90	20	91,36 €
039845-T	20W	FBK	2700K	2000	38°	>90	20	91,36 €
038107-T	20W	FBK	3000K	2000	38°	>90	20	91,36 €
038114-T	20W	FBK	4000K	2000	38°	>90	20	91,36 €
DALI/PUSH								
039838-D	20W	FW	2700K	2000	38°	>90	20	91,36 €
038084-D	20W	FW	3000K	2000	38°	>90	20	91,36 €
038091-D	20W	FW	4000K	2000	38°	>90	20	91,36 €
039845-D	20W	FBK	2700K	2000	38°	>90	20	91,36 €
038107-D	20W	FBK	3000K	2000	38°	>90	20	91,36 €
038114-D	20W	FBK	4000K	2000	38°	>90	20	91,36 €

ACCESORIOS/ACCESSORIES

REF.	DESCRIPCIÓN	P.V.P.
------	-------------	--------

ÓPTICAS/OPTICS

REF.	DESCRIPCIÓN	P.V.P.
038831	REFLECTOR 20W-15°	5,15 €
038848	REFLECTOR 20W-55°	5,15 €

SERIES LC3302 - 32W

REF.	POW.	ACABADO	CCT	LM	ANG.	CRI	IP	P.V.P.
039852	32W	FW	2700K	3000	38°	>90	20	68,54 €
038121	32W	FW	3000K	3000	38°	>90	20	68,54 €
038138	32W	FW	4000K	3000	38°	>90	20	68,54 €
039869	32W	FBK	2700K	3000	38°	>90	20	68,54 €
038145	32W	FBK	3000K	3000	38°	>90	20	68,54 €
038152	32W	FBK	4000K	3000	38°	>90	20	68,54 €

REGULACIONES/DIMMING

REF.	POW.	ACABADO	CCT	LM	ANG.	CRI	IP	P.V.P.
TRIAC								
039852-T	32W	FW	2700K	3000	38°	>90	20	103,54 €
038121-T	32W	FW	3000K	3000	38°	>90	20	103,54 €
038138-T	32W	FW	4000K	3000	38°	>90	20	103,54 €
039869-T	32W	FBK	2700K	3000	38°	>90	20	103,54 €
038145-T	32W	FBK	3000K	3000	38°	>90	20	103,54 €
038152-T	32W	FBK	4000K	3000	38°	>90	20	103,54 €
DALI/PUSH								
039852-D	32W	FW	2700K	3000	38°	>90	20	103,54 €
038121-D	32W	FW	3000K	3000	38°	>90	20	103,54 €
038138-D	32W	FW	4000K	3000	38°	>90	20	103,54 €
039869-D	32W	FBK	2700K	3000	38°	>90	20	103,54 €
038145-D	32W	FBK	3000K	3000	38°	>90	20	103,54 €
038152-D	32W	FBK	4000K	3000	38°	>90	20	103,54 €

ACCESORIOS/ACCESSORIES

REF.	DESCRIPCIÓN	P.V.P.
------	-------------	--------

ÓPTICAS/OPTICS

REF.	DESCRIPCIÓN	P.V.P.
038855	REFLECTOR 32W-15°	5,15 €
038862	REFLECTOR 32W-55°	5,15 €

SERIES LC3303



Al 20W 32W 2.700°K 3.000°K 4.000°K 5.700°K

AC
220V
240V

50.000h

15°

38°

55°

Hz
50/60

NO DIMMABLE



IP 20
RATED

CRI
>90



MACADAM
<3



RoHS
COMPLIANT



5 AÑOS
GARANTÍA

KGP CREE

DIMENSIONES DIMENSIONS

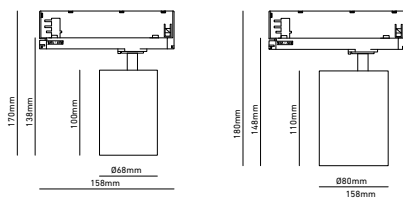

ACABADOS FINISHES



FOTOMETRÍA PHOTOMETRY

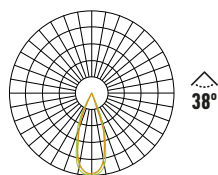

REGULACIÓN DIMMING

TRIAC - 0-10V - DALI

* CASAMBI A CONSULTAR

CCT ESPECIALES SPECIAL CCT



SERIES LC3303 - 20W

REF.	POW.	ACABADO	CCT	LM	ANG.	CRI	IP	P.V.P.
039876	20W	FW	2700K	2000	38°	>90	20	56,36 €
037988	20W	FW	3000K	2000	38°	>90	20	56,36 €
037995	20W	FW	4000K	2000	38°	>90	20	56,36 €
039883	20W	FBK	2700K	2000	38°	>90	20	56,36 €
038008	20W	FBK	3000K	2000	38°	>90	20	56,36 €
038015	20W	FBK	4000K	2000	38°	>90	20	56,36 €

REGULACIONES/DIMMING

REF.	POW.	ACABADO	CCT	LM	ANG.	CRI	IP	P.V.P.
TRIAC								
039876-T	20W	FW	2700K	2000	38°	>90	20	91,36 €
037988-T	20W	FW	3000K	2000	38°	>90	20	91,36 €
037995-T	20W	FW	4000K	2000	38°	>90	20	91,36 €
039883-T	20W	FBK	2700K	2000	38°	>90	20	91,36 €
038008-T	20W	FBK	3000K	2000	38°	>90	20	91,36 €
038015-T	20W	FBK	4000K	2000	38°	>90	20	91,36 €
DALI/PUSH								
039876-D	20W	FW	2700K	2000	38°	>90	20	91,36 €
037988-D	20W	FW	3000K	2000	38°	>90	20	91,36 €
037995-D	20W	FW	4000K	2000	38°	>90	20	91,36 €
039883-D	20W	FBK	2700K	2000	38°	>90	20	91,36 €
038008-D	20W	FBK	3000K	2000	38°	>90	20	91,36 €
038015-D	20W	FBK	4000K	2000	38°	>90	20	91,36 €

ACCESORIOS/ACCESSORIES

REF.	DESCRIPCIÓN	P.V.P.
------	-------------	--------

ÓPTICAS/OPTICS

REF.	DESCRIPCIÓN	P.V.P.
038794	REFLECTOR 20W-15°	5,15 €
038800	REFLECTOR 20W-55°	5,15 €

SERIES LC3303 - 32W

REF.	POW.	ACABADO	CCT	LM	ANG.	CRI	IP	P.V.P.
039890	32W	FW	2700K	3000	38°	>90	20	69,03 €
038022	32W	FW	3000K	3000	38°	>90	20	69,03 €
038039	32W	FW	4000K	3000	38°	>90	20	69,03 €
038046	32W	FW	5700K	3000	38°	>90	20	69,03 €
039906	32W	FBK	2700K	3000	38°	>90	20	69,03 €
038053	32W	FBK	3000K	3000	38°	>90	20	69,03 €
038060	32W	FBK	4000K	3000	38°	>90	20	69,03 €
038077	32W	FBK	5700K	3000	38°	>90	20	69,03 €

REGULACIONES/DIMMING

REF.	POW.	ACABADO	CCT	LM	ANG.	CRI	IP	P.V.P.
TRIAC								
039890-T	32W	FW	2700K	3000	38°	>90	20	104,03 €
038022-T	32W	FW	3000K	3000	38°	>90	20	104,03 €
038039-T	32W	FW	4000K	3000	38°	>90	20	104,03 €
038046-T	32W	FW	5700K	3000	38°	>90	20	104,03 €
039906-T	32W	FBK	2700K	3000	38°	>90	20	104,03 €
038053-T	32W	FBK	3000K	3000	38°	>90	20	104,03 €
038060-T	32W	FBK	4000K	3000	38°	>90	20	104,03 €
038077-T	32W	FBK	5700K	3000	38°	>90	20	104,03 €
DALI/PUSH								
039890-D	32W	FW	2700K	3000	38°	>90	20	104,03 €
038022-D	32W	FW	3000K	3000	38°	>90	20	104,03 €
038039-D	32W	FW	4000K	3000	38°	>90	20	104,03 €
038046-D	32W	FW	5700K	3000	38°	>90	20	104,03 €
039906-D	32W	FBK	2700K	3000	38°	>90	20	104,03 €
038053-D	32W	FBK	3000K	3000	38°	>90	20	104,03 €
038060-D	32W	FBK	4000K	3000	38°	>90	20	104,03 €
038077-D	32W	FBK	5700K	3000	38°	>90	20	104,03 €

ACCESORIOS/ACCESSORIES

REF.	DESCRIPCIÓN	P.V.P.
------	-------------	--------

ÓPTICAS/OPTICS

REF.	DESCRIPCIÓN	P.V.P.
038817	REFLECTOR 32W-15°	
038824	REFLECTOR 32W-55°	

SERIES LC3303 - 32W - CHIP ESPECIALES

REF.	POW.	ACABADO	CCT	LM	ANG.	CRI	IP	P.V.P.
038718	32W	FW	2700K	3000	38°	>90	20	89,03 €
038725	32W	FW	3000K	3000	38°	>90	20	89,03 €
038732	32W	FW	4000K	3000	38°	>90	20	89,03 €
038749	32W	FW	5700K	3000	38°	>90	20	89,03 €
038756	32W	FBK	2700K	3000	38°	>90	20	89,03 €
038763	32W	FBK	3000K	3000	38°	>90	20	89,03 €
038770	32W	FBK	4000K	3000	38°	>90	20	89,03 €
038787	32W	FBK	5700K	3000	38°	>90	20	89,03 €

REGULACIONES/DIMMING

REF.	POW.	ACABADO	CCT	LM	ANG.	CRI	IP	P.V.P.
TRIAC								
038718-T	32W	FW	2700K	3000	38°	>90	20	124,03 €
038725-T	32W	FW	3000K	3000	38°	>90	20	124,03 €
038732-T	32W	FW	4000K	3000	38°	>90	20	124,03 €
038749-T	32W	FW	5700K	3000	38°	>90	20	124,03 €
038756-T	32W	FBK	2700K	3000	38°	>90	20	124,03 €
038763-T	32W	FBK	3000K	3000	38°	>90	20	124,03 €
038770-T	32W	FBK	4000K	3000	38°	>90	20	124,03 €
038787-T	32W	FBK	5700K	3000	38°	>90	20	124,03 €
DALI/PUSH								
038718-D	32W	FW	2700K	3000	38°	>90	20	124,03 €
038725-D	32W	FW	3000K	3000	38°	>90	20	124,03 €
038732-D	32W	FW	4000K	3000	38°	>90	20	124,03 €
038749-D	32W	FW	5700K	3000	38°	>90	20	124,03 €
038756-D	32W	FBK	2700K	3000	38°	>90	20	124,03 €
038763-D	32W	FBK	3000K	3000	38°	>90	20	124,03 €
038770-D	32W	FBK	4000K	3000	38°	>90	20	124,03 €
038787-D	32W	FBK	5700K	3000	38°	>90	20	124,03 €

ACCESORIOS/ACCESSORIES

REF.	DESCRIPCIÓN	P.V.P.
------	-------------	--------

ÓPTICAS/OPTICS

REF.	DESCRIPCIÓN	P.V.P.
038817	REFLECTOR 32W-15°	5,15 €
038824	REFLECTOR 32W-55°	5,15 €

SERIES LC1562

CRI (RA) >97

**MÁXIMA
REPRODUCCIÓN
CROMÁTICA**
MAXIMUM
CHROMATIC
REPRODUCTION

KGP

BRIDGELUX.

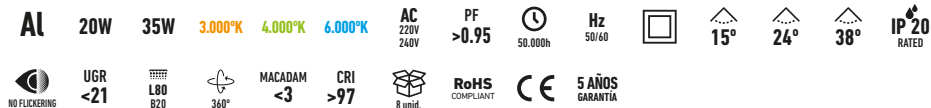

DIMENSIONES DIMENSIONS

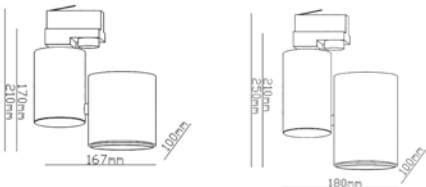

FOTOMETRÍA PHOTOMETRY

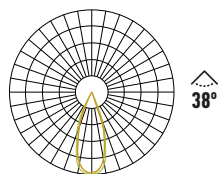

ACABADOS FINISHES



REGULACIÓN DIMMING

TRIAC - 0-10V - DALI

* **CASAMBI A CONSULTAR**

ACCESORIOS ACCESSORIES

ACCESORIO PARA INSTALACIÓN EN SUPERFICIE

ACCESSORY TO SURFACE INSTALLATION

20W: YLD-027057

35W: YLD-026647



SERIES LC1562 - 20W

REF.	POW.	ACABADO	CCT	LM	ANG.	CRI	IP	P.V.P.
019397	20W	FW	3000K	2000	38°	>90	20	95,75 €
021178	20W	FW	4000K	2000	38°	>90	20	95,75 €
019380	20W	FBK	3000K	2000	38°	>90	20	95,75 €
021161	20W	FBK	4000K	2000	38°	>90	20	95,75 €

ACCESORIOS/ACCESSORIES

REF.	DESCRIPCIÓN	P.V.P.
027057	ACC. INS. SUPERFICIE 20W	2,89

ÓPTICAS/OPTICS

REF.	DESCRIPCIÓN	P.V.P.
029389	REFLECTOR 20W-15°	5,15 €
991210	REFLECTOR 20W-24°	5,15 €

SERIES LC1562 - 35W

REF.	POW.	ACABADO	CCT	LM	ANG.	CRI	IP	P.V.P.
018383	35W	FW	3000K	2800	38°	>97	20	111,92
018390	35W	FW	4000K	2800	38°	>97	20	111,92
026890	35W	FW	6000K	2800	38°	>97	20	111,92
018475	35W	FBK	3000K	2800	38°	>97	20	111,92
018482	35W	FBK	4000K	2800	38°	>97	20	111,92
029372	35W	FBK	6000K	2800	38°	>97	20	111,92

REGULACIONES/DIMMING

REF.	POW.	ACABADO	CCT	LM	ANG.	CRI	IP	P.V.P.
TRIAC								
018383-T	35W	FW	3000K	2800	38°	>97	20	146,92
018390-T	35W	FW	4000K	2800	38°	>97	20	146,92
026890-T	35W	FW	6000K	2800	38°	>97	20	146,92
018475-T	35W	FBK	3000K	2800	38°	>97	20	146,92
018482-T	35W	FBK	4000K	2800	38°	>97	20	146,92
029372-T	35W	FBK	6000K	2800	38°	>97	20	146,92
DALI/PUSH								
018383-D	35W	FW	3000K	2800	38°	>97	20	146,92 €
018390-D	35W	FW	4000K	2800	38°	>97	20	146,92 €
026890-D	35W	FW	6000K	2800	38°	>97	20	146,92 €
018475-D	35W	FBK	3000K	2800	38°	>97	20	146,92 €
018482-D	35W	FBK	4000K	2800	38°	>97	20	146,92 €
029372-D	35W	FBK	6000K	2800	38°	>97	20	146,92 €

ACCESORIOS/ACCESSORIES

REF.	DESCRIPCIÓN	P.V.P.
026647	ACC. INS. SUPERFICIE 20W	2,89

ÓPTICAS/OPTICS

REF.	DESCRIPCIÓN	P.V.P.
029389	REFLECTOR 35W-15°	5,15 €
991210	REFLECTOR 35W-24°	5,15 €

SERIES LC3144 - SPECIAL RETAIL



- Al**
- 30W**
- 3.000°K**
- 4.000°K**
- 5.700°K**
- 2.800 LUMEN**
- AC 220V 240V**
- 50.000h**
- 15°**
- 38°**
- 55°**
- Hz 50/60**
- NO DIMMABLE**
- L80 B20**
- IP 20 RATED**
- CRI >90**
- 360°**
- MACADAM <3**
- NO FLICKERING**
- UGR <21**
- PF >0.95**
- 16 unid.**
- RoHS COMPLIANT**
- CE**
- 3 AÑOS GARANTÍA**

DIMENSIONES DIMENSIONS

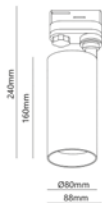

ACABADOS FINISHES



FOTOMETRÍA PHOTOMETRY



REGULACIÓN DIMMING

ACCESORIOS ACCESSORIES

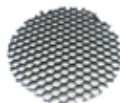

Accesorio
Panel Abeja

SERIES LC3144 - 30W

REF.	POW.	ACABADO	CCT	LM	ANG.	CRI	IP	P.V.P.
032600	30W	FW	3000K	2800	38°	>97	20	73,50 €
032617	30W	FW	4000K	2800	38°	>97	20	73,50 €
035960	30W	FW	5700K	2800	38°	>97	20	73,50 €
032624	30W	FBK	3000K	2800	38°	>97	20	73,50 €
032631	30W	FBK	4000K	2800	38°	>97	20	73,50 €
035977	30W	FBK	5700K	2800	38°	>97	20	73,50 €

ACCESORIOS/ACCESSORIES

REF.	DESCRIPCIÓN	P.V.P.
032730	ACCESORIO PANEL DE ABEJA	1,10 €

ÓPTICAS/OPTICS

REF.	DESCRIPCIÓN	P.V.P.
034277	REFLECTOR 30W-15°	5,15 €
034284	REFLECTOR 30W-55°	5,15 €

SERIES LC068 - PRECISI3N LIGHT



PRECISION LIGHT

ÁNGULO DE APERTURA 9° BEAM ANGLE 9°

AI



NO DIMMABLE

30W



9°

3.000°K

4.000°K

AC

120V

240V

PF

>0.95



50.000h

Hz

50/60



IP 20

RATED



NO FLICKERING

UGR

<21

L80

B20



360°

MACADAM

<3

CRI

>80



12 unid.

RoHS

COMPLIANT



5 AÑOS

GARANTÍA

DIMENSIONES DIMENSIONS

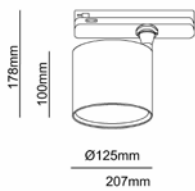

FOTOMETRÍA PHOTOMETRY

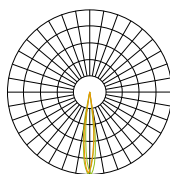

ACABADOS FINISHES



REGULACI3N DIMMING

SERIES LC068 - 30W

REF.	POW.	ACABADO	CCT	LM	ANG.	CRI	IP	P.V.P.
027958	30W	FW	3000K	2800	9°	>80	20	114,35 €
027965	30W	FW	4000K	2800	9°	>80	20	114,35 €
027972	30W	FBK	3000K	2800	9°	>80	20	114,35 €
027989	30W	FBK	4000K	2800	9°	>80	20	114,35 €

SERIES R004 - MONOFÁSICO



DIMENSIONES DIMENSIONS

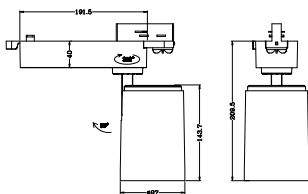

FOTOMETRÍA PHOTOMETRY

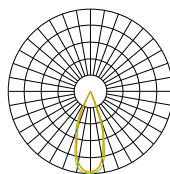

ACABADOS FINISHES



REGULACIÓN DIMMING

SERIES R004-2 - MONOFÁSICO - 33W

REF.	POW.	ACABADO	CCT	LM	ANG.	CRI	IP	P.V.P.
071005	33W	FW	3000K	2640	38	90	20	82,01 €

SERIES NC2189 - GU10



DIMENSIONES DIMENSIONS

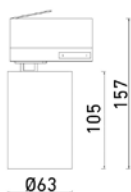

ACABADOS FINISHES



FOTOMETRÍA PHOTOMETRY

REGULACIÓN DIMMING

SERIES NC2189 - GU10

REF.	ACABADO	DIMENSIONES	IP	LAMP	P.V.P.
026111	FW	Ø63X105	20	GU10	39,27 €
026142	FBK	Ø63X106	20	GU10	39,27 €

CARRIL TRIFÁSICO THREE-PHASE TRACK

AI IP 20
RATED RoHS
COMPLIANT CE



CARRIL 1m 1m TRACK



REF.	ACABADO	P.V.P.
029358	FW	20,79 €
029365	FBK	20,79 €

CARRIL 2m 2m TRACK



REF.	ACABADO	P.V.P.
027309	FW	39,50 €
027316	FBK	39,50 €

CONECTOR T CONNECTOR T



REF.	ACABADO	DIRECCIÓN	P.V.P.
027507	FW	IZQUIERDA LEFT	9,36 €
027514	FW	DERECHA RIGHT	9,36 €
027521	FBK	IZQUIERDA LEFT	9,36 €
027538	FBK	DERECHA RIGHT	9,36 €

ACOMETIDA MAIN CONNECTOR



REF.	ACABADO	DIRECCIÓN	P.V.P.
027323	FW	IZQUIERDA LEFT	4,16 €
027330	FW	DERECHA RIGHT	4,16 €
027347	FBK	IZQUIERDA LEFT	4,16 €
027354	FBK	DERECHA RIGHT	4,16 €

CONECTOR L CONNECTOR L



REF.	ACABADO	DIRECCIÓN	P.V.P.
027460	FW	IZQUIERDA LEFT	7,28 €
027477	FW	DERECHA RIGHT	7,28 €
027484	FBK	IZQUIERDA LEFT	7,28 €
027491	FBK	DERECHA RIGHT	7,28 €

TAPA FINAL END CAP



REF.	ACABADO	P.V.P.
027361	FW	1,04 €
027378	FBK	1,04 €

CONECTOR INTERNO INNER CONNECTOR



REF.	ACABADO	P.V.P.
027385	FW	4,16 €
027392	FBK	4,16 €

PROLONGADOR 10cm EXTENDER FEED 10Cm



REF.	ACABADO	P.V.P.
027422	FW	7,28 €
027439	FBK	7,28 €

CONECTOR FLEXIBLE FLEXIBLE CONNECTOR



REF.	ACABADO	P.V.P.
027446	FW	19,96 €
027453	FBK	19,96 €

CABLE 3m 3m WIRE



REF.	ACABADO	P.V.P.
027545	FW	7,79 €
027552	FBK	7,79 €

CONECTOR X CONNECTOR X



REF.	ACABADO	P.V.P.
027408	FW	11,44 €
027415	FBK	11,44 €

BASE DE SUPERFICIE PARA FOCO CARRIL SURFACE BASE FOR FOCUS RAIL



REF.	ACABADO	P.V.P.
034512	FW	9,14 €
034529	FBK	9,14 €

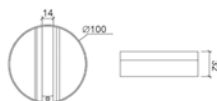

BASE TIPO SCHUKO PARA CARRIL TRIFÁSICO SCHUKO TYPE BASE FOR THREE PHASE RAIL



REF.	ACABADO	P.V.P.
031634	FW	24,83 €
031641	FBK	24,83 €

CARRIL TRIFÁSICO DALI DALI THREE-PHASE TRACK



CARRIL DE EMPOTRAR RECESSED TRACK

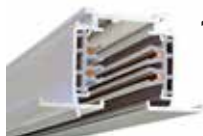

1m	REF.	ACABADO	P.V.P.	2m	REF.	ACABADO	P.V.P.
	990179	FW	44,39 €		990181	FW	88,77 €
	990180	FBK	44,39 €		990182	FBK	88,77 €

CARRIL DE SUPERFICIE SURFACE TRACK



1m	REF.	ACABADO	P.V.P.	2m	REF.	ACABADO	P.V.P.
	990183	FW	37,23 €		990185	FW	73,52 €
	990184	FBK	37,23 €		990186	FBK	73,52 €

CABLE 5m 5m WIRE



REF.	ACABADO	P.V.P.
990148	FW	17,10 €
990149	FBK	17,10 €

TAPA FINAL END CAP



REF.	ACABADO	P.V.P.
990191	FW	1,87 €
990192	FBK	1,87 €

ACOMETIDA MAIN CONNECTOR



REF.	ACABADO	DIRECCIÓN	P.V.P.
990187	FW	IZQUIERDA LEFT	18,76 €
990188	FW	DERECHA RIGHT	18,76 €
990189	FBK	IZQUIERDA LEFT	18,76 €
990190	FBK	DERECHA RIGHT	18,76 €

CONECTOR INTERNO INNER CONNECTOR



REF.	ACABADO	P.V.P.
990193	FW	12,97 €
990194	FBK	12,97 €

PROLONGADOR 10cm EXTENDER FEED 10Cm



REF.	ACABADO	P.V.P.
990197	FW	36,52 €
990198	FBK	36,52 €

CONECTOR FLEXIBLE FLEXIBLE CONNECTOR



REF.	ACABADO	P.V.P.
990138	FW	51,11 €
990139	FBK	51,11 €

CONECTOR X CONNECTOR X



REF.	ACABADO	P.V.P.
990195	FW	73,39 €
990196	FBK	73,39 €

CONECTOR L CONNECTOR L



REF.	ACABADO	DIRECCIÓN	P.V.P.
990140	FW	IZQUIERDA LEFT	37,96 €
990141	FW	DERECHA RIGHT	37,96 €
990142	FBK	IZQUIERDA LEFT	37,96 €
990143	FBK	DERECHA RIGHT	37,96 €

CONECTOR T CONNECTOR T



REF.	ACABADO	DIRECCIÓN	P.V.P.
990144	FW	IZQUIERDA LEFT	57,70 €
990145	FW	DERECHA RIGHT	57,70 €
990146	FBK	IZQUIERDA LEFT	57,70 €
990147	FBK	DERECHA RIGHT	57,70 €

CARRIL MONOFÁSICO Y ACCESORIOS

SINGLE PHASE TRACK AND ACCESSORIES

AI IP 20 RATED CE RoHS COMPLIANT

*ACOMETIDA Y TAPA INCLUIDAS

CARRIL 1m BLANCO 1m WHITE TRACK



REF.	ACABADO	P.V.P.
076512	FW	12,13 €

CARRIL 2m BLANCO 2m WHITE TRACK



REF.	ACABADO	P.V.P.
076529	FW	24,14 €

CONECTOR INTERNO BLANCO INNER CONNECTOR WHITE



REF.	ACABADO	P.V.P.
076598	FW	2,19 €

CONECTOR L BLANCO CONNECTOR L WHITE



REF.	ACABADO	P.V.P.
076611	FW	3,93 €

CONECTOR X BLANCO CONNECTOR X WHITE



REF.	ACABADO	P.V.P.
076659	FW	7,85 €

CONECTOR T BLANCO CONNECTOR T WHITE



REF.	ACABADO	P.V.P.
076635	FW	5,89 €

2.

MÓDULOS LED LED MODULES

SERIES YLD-220V - ALTO CRI

CRI (RA) >97

MÁXIMA REPRODUCCIÓN CROMÁTICA
MAXIMUM CHROMATIC REPRODUCTION



Al

AC
220V
240V

2.700°K

3.000°K

4.000°K

6.000°K

PF
>0.95

⌚
50.000h

Hz
50/60



IP 20
RATED

🌙
NO FLICKERING

📏
L80
B20

MACADAM
<3

CRI
>97



30 unid.

RoHS
COMPLIANT



5 AÑOS
GARANTÍA

DIMENSIONES DIMENSIONS

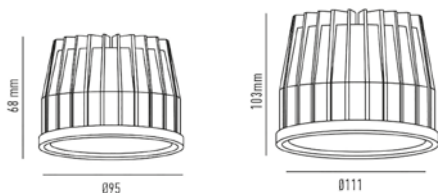

ACABADOS FINISHES



FOTOMETRÍA PHOTOMETRY



REGULACIÓN DIMMING

TRIAC - 0-10V - DALI

* CASAMBI A CONSULTAR

CCT ESPECIALES SPECIAL CCT



SERIES YLD-220V - 20W

REF.	POW.	ACABADO	CCT	LM	ANG.	CRI	IP	P.V.P.
039913	20W	GRIS	2700K	1600	38°	>97	20	60,77 €
019953	20W	GRIS	3000K	1600	38°	>97	20	60,77 €
021727	20W	GRIS	4000K	1600	38°	>97	20	60,77 €
021734	20W	GRIS	6000K	1600	38°	>97	20	60,77 €

REGULACIONES/DIMMING

REF.	POW.	ACABADO	CCT	LM	ANG.	CRI	IP	P.V.P.
TRIAC								
039913-T	20W	GRIS	2700K	1600	38°	>97	20	95,77 €
019953-T	20W	GRIS	3000K	1600	38°	>97	20	95,77 €
021727-T	20W	GRIS	4000K	1600	38°	>97	20	95,77 €
021734-T	20W	GRIS	6000K	1600	38°	>97	20	95,77 €
0-10V								
039913-0	20W	GRIS	2700K	1600	38°	>97	20	95,77 €
019953-0	20W	GRIS	3000K	1600	38°	>97	20	95,77 €
021727-0	20W	GRIS	4000K	1600	38°	>97	20	95,77 €
021734-0	20W	GRIS	6000K	1600	38°	>97	20	95,77 €
DALI/PUSH								
039913-D	20W	GRIS	2700K	1600	38°	>97	20	95,77 €
019953-D	20W	GRIS	3000K	1600	38°	>97	20	95,77 €
021727-D	20W	GRIS	4000K	1600	38°	>97	20	95,77 €
021734-D	20W	GRIS	6000K	1600	38°	>97	20	95,77 €

ÓPTICAS/OPTICS

REF.	DESCRIPCIÓN	P.V.P.
021604	ACC. REFLECTOR YLD-220V-20W-10°	5,15
021611	ACC. REFLECTOR YLD-220V-20W-23°	5,15

SERIES YLD-220V - 35W

REF.	POW.	ACABADO	CCT	LM	ANG.	CRI	IP	P.V.P.
039920	35W	GRIS	2700K	2800	38°	>97	20	78,41 €
019984	35W	GRIS	3000K	2800	38°	>97	20	78,41 €
021765	35W	GRIS	4000K	2800	38°	>97	20	78,41 €
021772	35W	GRIS	6000K	2800	38°	>97	20	78,41 €

REGULACIONES/DIMMING

REF.	POW.	ACABADO	CCT	LM	ANG.	CRI	IP	P.V.P.
TRIAC								
039920-T	35W	GRIS	2700K	2800	38°	>97	20	113,41 €
019984-T	35W	GRIS	3000K	2800	38°	>97	20	113,41 €
021765-T	35W	GRIS	4000K	2800	38°	>97	20	113,41 €
021772-T	35W	GRIS	6000K	2800	38°	>97	20	113,41 €
0-10V								
039920-0	35W	GRIS	2700K	2800	38°	>97	20	113,41 €
019984-0	35W	GRIS	3000K	2800	38°	>97	20	113,41 €
021765-0	35W	GRIS	4000K	2800	38°	>97	20	113,41 €
021772-0	35W	GRIS	6000K	2800	38°	>97	20	113,41 €
DALI/PUSH								
039920-D	35W	GRIS	2700K	2800	38°	>97	20	113,41 €
019984-D	35W	GRIS	3000K	2800	38°	>97	20	113,41 €
021765-D	35W	GRIS	4000K	2800	38°	>97	20	113,41 €
021772-D	35W	GRIS	6000K	2800	38°	>97	20	113,41 €

ÓPTICAS/OPTICS

REF.	DESCRIPCIÓN	P.V.P.
029389	ACC. REFLECTOR YLD-220V-35W-15°	5,15
991210	ACC. REFLECTOR YLD-220V-35W-24°	5,15

SERIES YLD-220V - 35W - CHIP ESPECIALES

REF.	POW.	ACABADO	CCT	LM	ANG.	CRI	IP	P.V.P.
005819	35W	GRIS	BREAD	2800	38°	>97	20	98,41 €
005922	35W	GRIS	MEAT	2800	38°	>97	20	98,41 €
005994	35W	GRIS	VEGETABLES	2800	38°	>97	20	98,41 €
006021	35W	GRIS	FISH	2800	38°	>97	20	98,41 €

REGULACIONES/DIMMING

REF.	POW.	ACABADO	CCT	LM	ANG.	CRI	IP	P.V.P.
TRIAC								
005819-T	35W	GRIS	BREAD	2800	38°	>97	20	133,41 €
005922-T	35W	GRIS	MEAT	2800	38°	>97	20	133,41 €
005994-T	35W	GRIS	VEGETABLES	2800	38°	>97	20	133,41 €
006021-T	35W	GRIS	FISH	2800	38°	>97	20	133,41 €
0-10V								
005819-0	35W	GRIS	BREAD	2800	38°	>97	20	133,41 €
005922-0	35W	GRIS	MEAT	2800	38°	>97	20	133,41 €
005994-0	35W	GRIS	VEGETABLES	2800	38°	>97	20	133,41 €
006021-0	35W	GRIS	FISH	2800	38°	>97	20	133,41 €
DALI/PUSH								
005819-D	35W	GRIS	BREAD	2800	38°	>97	20	133,41 €
005922-D	35W	GRIS	MEAT	2800	38°	>97	20	133,41 €
005994-D	35W	GRIS	VEGETABLES	2800	38°	>97	20	133,41 €
006021-D	35W	GRIS	FISH	2800	38°	>97	20	133,41 €

ÓPTICAS/OPTICS

REF.	DESCRIPCIÓN	P.V.P.
029389	ACC. REFLECTOR YLD-220V-35W-15°	5,15
991210	ACC. REFLECTOR YLD-220V-35W-24°	5,15

SERIES NC2116 - ACCESORIOS YLD-220V



DIMENSIONES DIMENSIONS

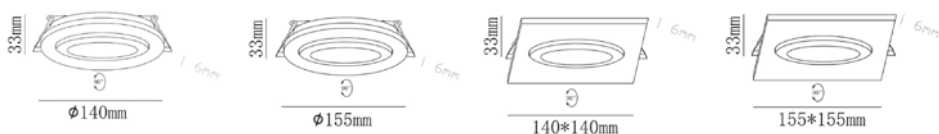

ACABADOS FINISHES



NC2116 20W REDONDO

REF.	ACABADO	DIMENSIONES (mm)	ØCUT (mm)	FORMATO	OSCILANTE	IP	P.V.P.
019793	W	Ø140X33	Ø130	REDONDO	SI	20	23,72 €
019779	CH	Ø140X33	Ø130	REDONDO	SI	20	29,49 €

NC2116 20W CUADRADO

REF.	ACABADO	DIMENSIONES (mm)	ØCUT (mm)	FORMATO	OSCILANTE	IP	P.V.P.
019731	W	140X140X33	Ø130	CUADRADO	SI	20	31,12 €
019717	CH	140X140X33	Ø130	CUADRADO	SI	20	40,02 €

NC2116 35W REDONDO

REF.	ACABADO	DIMENSIONES (mm)	ØCUT (mm)	FORMATO	OSCILANTE	IP	P.V.P.
019762	W	Ø155X33	Ø145	REDONDO	SI	20	26,53 €
019748	CH	Ø155X34	Ø145	REDONDO	SI	20	32,61 €

NC2116 35W CUADRADO

REF.	ACABADO	DIMENSIONES (mm)	ØCUT (mm)	FORMATO	OSCILANTE	IP	P.V.P.
019700	W	155X155X33	Ø145	CUADRADO	SI	20	38,54 €
019687	CH	155X155X34	Ø145	CUADRADO	SI	20	47,43 €

SERIES NC2119 - ACCESORIOS YLD-220V



DIMENSIONES DIMENSIONS

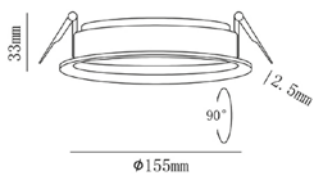
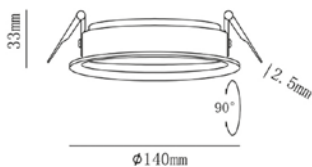

ACABADOS FINISHES



NC2119 20W REDONDO

REF.	ACABADO	DIMENSIONES (mm)	ØCUT (mm)	FORMATO	OSCILANTE	IP	P.V.P.
019922	W	Ø140X33	Ø125	REDONDO	SI	20	23,13 €
039937	FBK	Ø140X33	Ø125	REDONDO	SI	20	23,13 €
019908	CH	Ø140X33	Ø125	REDONDO	SI	20	29,50 €
039944	RC	Ø140X33	Ø125	REDONDO	SI	20	29,50 €
039951	G	Ø140X33	Ø125	REDONDO	SI	20	29,50 €

NC2119 35W REDONDO

REF.	ACABADO	DIMENSIONES (mm)	ØCUT (mm)	FORMATO	OSCILANTE	IP	P.V.P.
019885	W	Ø155X33	Ø140	REDONDO	SI	20	25,05 €
026838	FBK	Ø155X33	Ø140	REDONDO	SI	20	25,05 €
019861	CH	Ø155X33	Ø140	REDONDO	SI	20	35,58 €
019878	RC	Ø155X33	Ø140	REDONDO	SI	20	35,58 €
021598	G	Ø155X33	Ø140	REDONDO	SI	20	35,58 €

SERIES NC2118 - ACCESORIOS YLD-220V



Al IP20 RATED   10 unid. CE RoHS COMPLIANT

DIMENSIONES DIMENSIONS

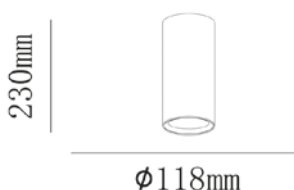
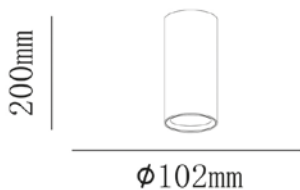

ACABADOS FINISHES



NC2118 20W SUPERFICIE

REF.	ACABADO	DIMENSIONES (mm)	ØCUT (mm)	FORMATO	OSCILANTE	IP	P.V.P.
021819	W	Ø140X33	Ø125	REDONDO	NO	20	23,13 €
029341	FBK	Ø140X33	Ø125	REDONDO	NO	20	23,13 €
021826	CH	Ø140X33	Ø125	REDONDO	NO	20	29,49 €

NC2118 20W SUPERFICIE IP54

REF.	ACABADO	DIMENSIONES (mm)	ØCUT (mm)	FORMATO	OSCILANTE	IP	P.V.P.
039975	W	Ø140X33	Ø125	REDONDO	NO	54	33,13 €
039982	FBK	Ø140X33	Ø125	REDONDO	NO	54	33,13 €
039999	CH	Ø140X33	Ø125	REDONDO	NO	54	39,49 €

NC2118 35W SUPERFICIE

REF.	ACABADO	DIMENSIONES (mm)	ØCUT (mm)	FORMATO	OSCILANTE	IP	P.V.P.
021833	W	Ø155X33	Ø140	REDONDO	NO	20	25,05 €
040001	FBK	Ø155X33	Ø140	REDONDO	NO	20	25,05 €
021840	CH	Ø155X33	Ø140	REDONDO	NO	20	33,95 €

NC2118 35W SUPERFICIE IP54

REF.	ACABADO	DIMENSIONES (mm)	ØCUT (mm)	FORMATO	OSCILANTE	IP	P.V.P.
040018	W	Ø155X33	Ø140	REDONDO	NO	54	35,05 €
040025	FBK	Ø155X33	Ø140	REDONDO	NO	54	35,05 €
040032	CH	Ø155X33	Ø140	REDONDO	NO	54	43,95 €

SERIES NC2138 - ACCESORIOS YLD-220V



PINTABLE
PAINTABLE

Al

IP20
RATED



10 unid.

CE

RoHS
COMPLIANT

DIMENSIONES DIMENSIONS



ACABADOS FINISHES



NC2138 20W REDONDO

REF.	ACABADO	DIMENSIONES (mm)	ØCUT (mm)	FORMATO	OSCILANTE	IP	P.V.P.
021116	FW	Ø170X95	Ø160	REDONDO	NO	20	21,92 €
025015	FBK	Ø170X95	Ø160	REDONDO	NO	20	21,92 €

NC2138 35W REDONDO

REF.	ACABADO	DIMENSIONES (mm)	ØCUT (mm)	FORMATO	OSCILANTE	IP	P.V.P.
021109	FW	Ø180X105	Ø170	REDONDO	NO	20	23,81 €
025022	FBK	Ø180X105	Ø170	REDONDO	NO	20	23,81 €

SERIES NC2156 - ACCESORIOS YLD-220V



DIMENSIONES DIMENSIONS



ACABADOS FINISHES



NC2156 20W ORIENTABLE

REF.	ACABADO	DIMENSIONES (mm)	ØCUT (mm)	FORMATO	OSCILANTE	IP	P.V.P.
024018	FW	Ø132X146	Ø115	REDONDO	SI	20	73,71 €
025077	FBK	Ø132X146	Ø115	REDONDO	SI	20	73,71 €

NC2156 35W ORIENTABLE

REF.	ACABADO	DIMENSIONES (mm)	ØCUT (mm)	FORMATO	OSCILANTE	IP	P.V.P.
024025	FW	Ø148X167	Ø130	REDONDO	SI	20	91,35 €
025084	FBK	Ø148X167	Ø130	REDONDO	SI	20	91,35 €

SERIES LD607



Al	35W	2.940 LUMEN	3.000°K 38°	4.000°K 60°	38°	AC 220V 240V	PF >0.95	50.000h	Hz 50/60		IP 20 RATED	 NO FLICKERING	 L80 B20	UGR <21
MACADAM <3	CRI >90	 18 unid.	RoHS COMPLIANT	CE	5 AÑOS GARANTÍA									

DIMENSIONES DIMENSIONS

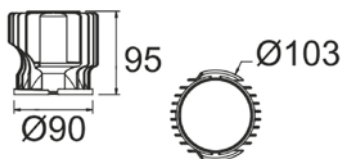

ACABADOS FINISHES



FOTOMETRÍA PHOTOMETRY

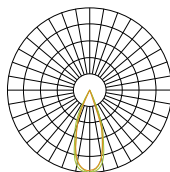

REGULACIÓN DIMMING

TRIAC - 0-10V - DALI

* CASAMBI A CONSULTAR

SERIES LD607 - 35W

REF.	POW.	ACABADO	CCT	LM	ANG.	CRI	IP	P.V.P.
071951	35W	NEGRO	3000K	2940	38°	>90	20	65,08 €
071036	35W	NEGRO	4000K	2940	38°	>90	20	65,08 €

REGULACIONES/DIMMING

REF.	POW.	ACABADO	CCT	LM	ANG.	CRI	IP	P.V.P.
TRIAC								
071951-T	35W	NEGRO	3000K	2940	38°	>90	20	99,99 €
071036-T	35W	NEGRO	4000K	2940	38°	>90	20	99,99 €
0-10V								
071951-0	35W	NEGRO	3000K	2940	38°	>90	20	99,99 €
071036-0	35W	NEGRO	4000K	2940	38°	>90	20	99,99 €
DALI/PUSH								
071951-D	35W	NEGRO	3000K	2940	38°	>90	20	99,99 €
071036-D	35W	NEGRO	4000K	2940	38°	>90	20	99,99 €

SERIES LD641 - ACCESORIOS LD607



DIMENSIONES DIMENSIONS

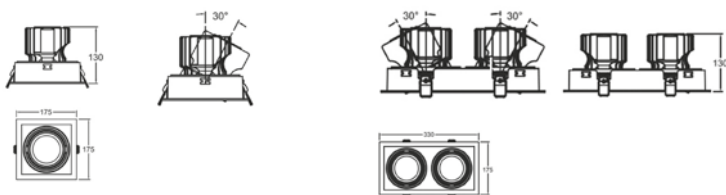

ACABADOS FINISHES

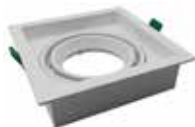

LD641 CUADRADO

REF.	ACABADO	DIMENSIONES (mm)	ØCUT (mm)	FORMATO	OSCILANTE	IP	P.V.P.
071043	FW	175X175X130	160X160	CUADRADO	SI	20	26,63 €
029013	FBK	175X175X130	160X160	CUADRADO	SI	20	26,63 €

LD641 CUADRADO DOBLE

REF.	ACABADO	DIMENSIONES (mm)	ØCUT (mm)	FORMATO	OSCILANTE	IP	P.V.P.
071050	FW	330X175X130	315X160	CUADRADO	SI	20	46,06 €
029020	FBK	330X175X130	315X160	CUADRADO	SI	20	46,06 €

SERIES LD627/LD607 - ACCESORIOS LD607



DIMENSIONES DIMENSIONS

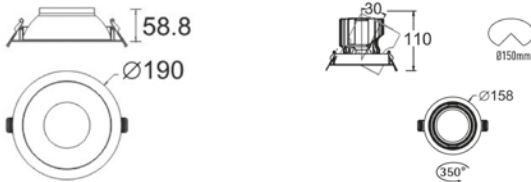

ACABADOS FINISHES



LD627 REDONDO FIJO

REF.	ACABADO	DIMENSIONES (mm)	ØCUT (mm)	FORMATO	OSCILANTE	IP	P.V.P.
071548	FW	Ø190X58,8	Ø170	REDONDO	NO	20	17,53 €
040056	FBK	Ø190X58,8	Ø170	REDONDO	NO	20	17,53 €

LD607 REDONDO ORIENTABLE

REF.	ACABADO	DIMENSIONES (mm)	ØCUT (mm)	FORMATO	OSCILANTE	IP	P.V.P.
071494	FW	Ø158X110	Ø150	REDONDO	SI	20	19,16 €
040063	FBK	Ø158X110	Ø150	REDONDO	SI	20	19,16 €

*Acabado FBK bajo pedido

SERIES YLD-222



Al 9W 12W 2.700°K 3.000°K 4.000°K 15° 38° 55° AC 220V 240V 50.000h NO FLICKERING Hz 50/60 IP20 RATED

MACADAM <3 UGR <21 CRI >90 48 unid. RoHS COMPLIANT CE 3 AÑOS GARANTÍA

DIMENSIONES DIMENSIONS

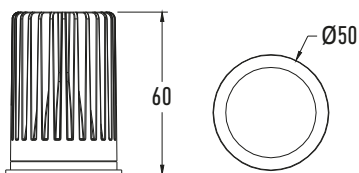

ACABADOS FINISHES



FOTOMETRÍA PHOTOMETRY

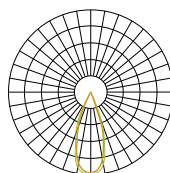

REGULACIÓN DIMMING

TRIAC - 0-10V - DALI

* CASAMBI A CONSULTAR

SERIES YLD-222 - 9W

REF.	POW.	ACABADO	CCT	LM	ANG.	CRI	IP	P.V.P.
037131	9W	GRIS	2700K	820	38°	>90	20	17,55 €
037162	9W	GRIS	3000K	860	38°	>90	20	17,55 €
037193	9W	GRIS	4000K	865	38°	>90	20	17,55 €

REGULACIONES/DIMMING

REF.	POW.	ACABADO	CCT	LM	ANG.	CRI	IP	P.V.P.
TRIAC								
037131-T	9W	GRIS	2700K	820	38°	>90	20	52,55 €
037162-T	9W	GRIS	3000K	860	38°	>90	20	52,55 €
037193-T	9W	GRIS	4000K	865	38°	>90	20	52,55 €
0-10V								
037131-0	9W	GRIS	2700K	820	38°	>90	20	52,55 €
037162-0	9W	GRIS	3000K	860	38°	>90	20	52,55 €
037193-0	9W	GRIS	4000K	865	38°	>90	20	52,55 €
DALI/PUSH								
037131-D	9W	GRIS	2700K	820	38°	>90	20	52,55 €
037162-D	9W	GRIS	3000K	860	38°	>90	20	52,55 €
037193-D	9W	GRIS	4000K	865	38°	>90	20	52,55 €

ÓPTICAS/OPTICS

REF.	DESCRIPCIÓN	P.V.P.
038370	ACC. REFLECTOR YLD-222-9W-15°	5,15 €
038371	ACC. REFLECTOR YLD-222-9W-55°	5,15 €

SERIES YLD-222 - 12W

REF.	POW.	ACABADO	CCT	LM	ANG.	CRI	IP	P.V.P.
037223	12W	GRIS	2700K	1170	38°	>90	20	18,72 €
037254	12W	GRIS	3000K	1180	38°	>90	20	18,72 €
037285	12W	GRIS	4000K	1185	38°	>90	20	18,72 €

REGULACIONES/DIMMING

REF.	POW.	ACABADO	CCT	LM	ANG.	CRI	IP	P.V.P.
TRIAC								
037223-T	12W	GRIS	2700K	1170	38°	>90	20	53,72 €
037254-T	12W	GRIS	3000K	1180	38°	>90	20	53,72 €
037285-T	12W	GRIS	4000K	1185	38°	>90	20	53,72 €
0-10V								
037223-0	12W	GRIS	2700K	1170	38°	>90	20	53,72 €
037254-0	12W	GRIS	3000K	1180	38°	>90	20	53,72 €
037285-0	12W	GRIS	4000K	1185	38°	>90	20	53,72 €
DALI/PUSH								
037223-D	12W	GRIS	2700K	1170	38°	>90	20	53,72 €
037254-D	12W	GRIS	3000K	1180	38°	>90	20	53,72 €
037285-D	12W	GRIS	4000K	1185	38°	>90	20	53,72 €

ÓPTICAS/OPTICS

REF.	DESCRIPCIÓN	P.V.P.
038370	ACC. REFLECTOR YLD-222-12W-15°	5,15 €
038371	ACC. REFLECTOR YLD-222-12W-55°	5,15 €

SERIES YLD-223 - CCT



SELECTOR CCT

Sistema para elegir la temperatura de color mediante interruptor. Permite seleccionar entre blanco cálido (3000K), neutro (4000K) y frío (6000K).



CERAMIC

7W

806
LUMEN

AC
220V
240V

60°

CRI
>80

30.000h

CCT
3000K/4000K
6000K

RoHS
COMPLIANT



DIMENSIONES DIMENSIONS

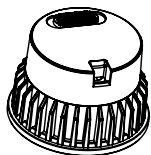
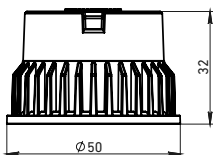

FOTOMETRÍA PHOTOMETRY

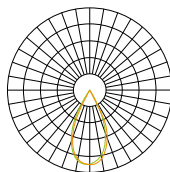

ACABADOS FINISHES



REGULACIÓN DIMMING

SERIES YLD-223 - 7W

REF.	POW.	ACABADO	CCT	LM	ANG.	CRI	IP	P.V.P.
038985	7W	W	3000K 4000K 5700K	806	60°	>80	20	7,11 €

3.

**DOWNLIGHT DE
EMPOTRAR**
RECESSED
DOWNLIGHT

SERIES LD361



AI **38W** **3.200** LUMEN **38°** **3.000°K** **4.000°K** **AC** 200V 240V **PF >0.95** **50.000h** **Hz** 50/60 **IP 20** RATED **360°** **Ø170mm** **L80 B20**
UGR <21 **MACADAM <3** **CRI >90** **NO FLICKERING** **8 unid.** **RoHS COMPLIANT** **CE** **3 AÑOS GARANTÍA** **TRIDONIC**

DIMENSIONES DIMENSIONS

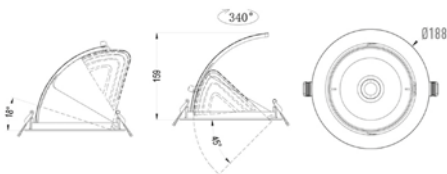

ACABADOS FINISHES



FOTOMETRÍA PHOTOMETRY

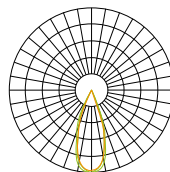

REGULACIÓN DIMMING

TRIAC - 0-10V - DALI

*** CASAMBI A CONSULTAR**



SERIES LD361 - 38W

REF.	POW.	ACABADO	CCT	LM	ANG.	CRI	IP	P.V.P.
071944	38W	FW	3000K	3200	38°	>90	20	103,13 €
071029	38W	FW	4000K	3200	38°	>90	20	103,13 €

REGULACIONES/DIMMING

REF.	POW.	ACABADO	CCT	LM	ANG.	CRI	IP	P.V.P.
TRIAC								
071944-T	38W	FW	3000K	3200	38°	>90	20	138,13 €
071029-T	38W	FW	4000K	3200	38°	>90	20	138,13 €

0-10V								
071944-0	38W	FW	3000K	3200	38°	>90	20	138,13 €
071029-0	38W	FW	4000K	3200	38°	>90	20	138,13 €

DALI/PUSH								
071944-D	38W	FW	3000K	3200	38°	>90	20	138,13 €
071029-D	38W	FW	4000K	3200	38°	>90	20	138,13 €

SERIES LF152



AI 38W 3.200 LUMEN 38° 3.000°K 4.000°K AC 200V 240V PF >0.95 50.000h Hz 50/60 IP 20 RATED 360° Ø170mm L80 B20

UGR <21 MACADAM <3 CRI >90 NO FLICKERING 8 unid. RoHS COMPLIANT CE 3 AÑOS GARANTÍA **TRIDONIC**

DIMENSIONES DIMENSIONS

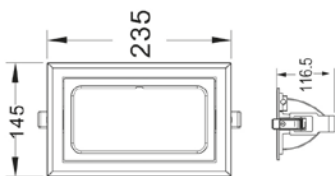

ACABADOS FINISHES



FOTOMETRÍA PHOTOMETRY

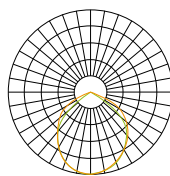

REGULACIÓN DIMMING

TRIAC - 0-10V - DALI

* CASAMBI A CONSULTAR



SERIES LD152 - 35W

REF.	POW.	ACABADO	CCT	LM	ANG.	CRI	IP	P.V.P.
071913	35W	FW	3000K	3200	110°	>80	20	91,59 €
071920	35W	FW	4000K	3200	110°	>80	20	91,59 €

REGULACIONES/DIMMING

REF.	POW.	ACABADO	CCT	LM	ANG.	CRI	IP	P.V.P.
TRIAC								
071913-T	35W	FW	3000K	3200	110°	>80	20	126,59 €
071920-T	35W	FW	4000K	3200	110°	>80	20	126,59 €

0-10V								
071913-0	35W	FW	3000K	3200	110°	>80	20	126,59 €
071920-0	35W	FW	4000K	3200	110°	>80	20	126,59 €

DALI/PUSH								
071913-D	35W	FW	3000K	3200	110°	>80	20	126,59 €
071920-D	35W	FW	4000K	3200	110°	>80	20	126,59 €

SERIES LC505



SELECTOR CCT
 Sistema para elegir la temperatura de color mediante interruptor. Permite seleccionar entre blanco cálido (3000K), neutro (3500K) y frío (4000K).

Al **8W** **12W** **18W** **720 LUMEN** **1.080 LUMEN** **1.440 LUMEN** **15°** **38°** **60°** **CCT 3000K/3500K/4000K** **AC 200V 240V** **50.000h** **IP 20 RATED** **Hz 50/60**
CRI >90 **NO FLICKERING** **RoHS COMPLIANT** **CE** **3 AÑOS GARANTÍA** **KGP**

DIMENSIONES DIMENSIONS

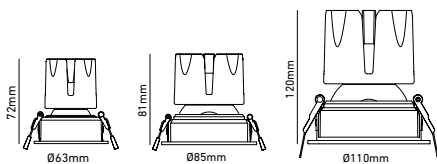

ACABADOS FINISHES



FOTOMETRÍA PHOTOMETRY

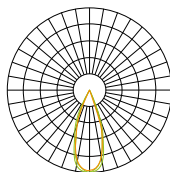

REGULACIÓN DIMMING

ACCESORIOS ACCESSORIES



SERIES LC505 - 8W

REF.	POW.	ACABADO	CCT	LM	ANG.	OSCILANTE CUT (mm)	P.V.P.
038282	8W	FW	3000K 3500K 4000K	720	38	SI Ø55	22,52 €

ACCESORIOS/ACCESSORIES

REF.	DESCRIPCIÓN	P.V.P.
038350	D63- REFLECTOR FW	1,15 €
038351	D63- REFLECTOR FBK	1,15 €
038352	D63- REFLECTOR BK	1,15 €
038353	D63- REFLECTOR CH	1,15 €
038354	D63- TRIMLESS FW	1,15 €

ÓPTICAS/OPTICS

REF.	DESCRIPCIÓN	P.V.P.
038355	D63-LENS 15°	0,90 €

SERIES LC505 - 12W

REF.	POW.	ACABADO	CCT	LM	ANG.	OSCILANTE CUT (mm)	P.V.P.
038299	12W	FW	3000K 3500K 4000K	1080	38	SI Ø75	25,56 €

ACCESORIOS/ACCESSORIES

REF.	DESCRIPCIÓN	P.V.P.
038356	D85- REFLECTOR FW	1,48 €
038357	D85- REFLECTOR FBK	1,48 €
038358	D85- REFLECTOR BK	1,48 €
038359	D85- REFLECTOR CH	1,48 €
038360	D85- TRIMLESS FW	1,48 €

ÓPTICAS/OPTICS

REF.	DESCRIPCIÓN	P.V.P.
038361	D85-LENS 15°	1,30 €
038362	D85-LENS 60°	1,30 €

SERIES LC505 - 18W

REF.	POW.	ACABADO	CCT	LM	ANG.	OSCILANTE CUT (mm)	P.V.P.
038336	18W	FW	3000K 3500K 4000K	1440	38	SI Ø95	45,56 €

ACCESORIOS/ACCESSORIES

REF.	DESCRIPCIÓN	P.V.P.
038363	D110- REFLECTOR FW	1,82 €
038364	D110- REFLECTOR FBK	1,82 €
038365	D110- REFLECTOR BK	1,82 €
038366	D110- REFLECTOR CH	1,82 €
038367	D110- TRIMLESS FW	1,82 €

ÓPTICAS/OPTICS

REF.	DESCRIPCIÓN	P.V.P.
038368	D110-LENS 15°	1,50 €
038369	D110-LENS 60°	1,50 €

SERIES KED743



Al	8W	12W	20W	640 LUMEN	960 LUMEN	1600 LUMEN	2.700°K	3.000°K	4.000°K					
			AC 100V 240V	Hz 50/60	CRI >95	PF >0.9		IP44 RATED	IP65 RATED	RoHS COMPLIANT		5 AÑOS GARANTÍA		

DIMENSIONES DIMENSIONS

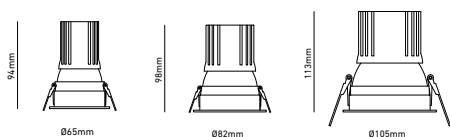

FOTOMETRÍA PHOTOMETRY

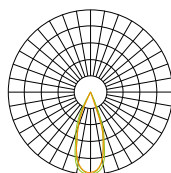

ACABADOS FINISHES



REGULACIÓN DIMMING

TRIAC - 0-10V - DALI

* CASAMBI A CONSULTAR

ACCESORIOS ACCESSORIES



SERIES KED743

VISTA DESPIECE EXPLODED VIEW



KED743 8W IP44

REF.	POW.	ACABADO	CCT	LM	ANG.	OSCILANTE CUT (mm)	P.V.P.
040070	8W	FW	2700K	640	36°	SI Ø55	31,41 €
040087	8W	FW	3000K	640	36°	SI Ø55	31,41 €
040094	8W	FW	4000K	640	36°	SI Ø55	31,41 €
040100	8W	FBK	2700K	640	36°	SI Ø55	31,41 €
040117	8W	FBK	3000K	640	36°	SI Ø55	31,41 €
040124	8W	FBK	4000K	640	36°	SI Ø55	31,41 €

REGULACIONES/DIMMING

REF.	POW.	ACABADO	CCT	LM	ANG.	OSCILANTE CUT (mm)	P.V.P.
TRIAC							
040070-T	8W	FW	2700K	640	36°	SI Ø55	66,41 €
040087-T	8W	FW	3000K	640	36°	SI Ø55	66,41 €
040094-T	8W	FW	4000K	640	36°	SI Ø55	66,41 €
040100-T	8W	FBK	2700K	640	36°	SI Ø55	66,41 €
040117-T	8W	FBK	3000K	640	36°	SI Ø55	66,41 €
040124-T	8W	FBK	4000K	640	36°	SI Ø55	66,41 €
0-10V							
040070-0	8W	FW	2700K	640	36°	SI Ø55	66,41 €
040087-0	8W	FW	3000K	640	36°	SI Ø55	66,41 €
040094-0	8W	FW	4000K	640	36°	SI Ø55	66,41 €
040100-0	8W	FBK	2700K	640	36°	SI Ø55	66,41 €
040117-0	8W	FBK	3000K	640	36°	SI Ø55	66,41 €
040124-0	8W	FBK	4000K	640	36°	SI Ø55	66,41 €
DALI/PUSH							
040070-D	8W	FW	2700K	640	36°	SI Ø55	66,41 €
040087-D	8W	FW	3000K	640	36°	SI Ø55	66,41 €
040094-D	8W	FW	4000K	640	36°	SI Ø55	66,41 €
040100-D	8W	FBK	2700K	640	36°	SI Ø55	66,41 €
040117-D	8W	FBK	3000K	640	36°	SI Ø55	66,41 €
040124-D	8W	FBK	4000K	640	36°	SI Ø55	66,41 €

ÓPTICAS/OPTICS

REF.	DESCRIPCIÓN	P.V.P.
006915	C55-LENS 15°	0,90 €
006922	C55-LENS 24°	0,90 €
007066	C55-LENS 60°	0,90 €
007127	C55-LINEAL LENS	2,00 €
007158	C55-SIMPLE ASIMÉTRICA	2,00 €
007189	C55-DOBLE ASIMÉTRICA	2,00 €
007219	C55 PANEL DE ABEJA	2,00 €

*Panel de abeja solo disponible en IP44

KED743 8W IP65

REF.	POW.	ACABADO	CCT	LM	ANG.	OSCILANTE CUT (mm)	P.V.P.
040131	8W	FW	2700K	640	36°	SI Ø55	34,58 €
010148	8W	FW	3000K	640	36°	SI Ø55	34,58 €
040155	8W	FW	4000K	640	36°	SI Ø55	34,58 €
040162	8W	FBK	2700K	640	36°	SI Ø55	34,58 €
040179	8W	FBK	3000K	640	36°	SI Ø55	34,58 €
040186	8W	FBK	4000K	640	36°	SI Ø55	34,58 €

REGULACIONES/DIMMING

REF.	POW.	ACABADO	CCT	LM	ANG.	OSCILANTE CUT (mm)	P.V.P.
TRIAC							
040131-T	8W	FW	2700K	640	36°	SI Ø55	69,58 €
010148-T	8W	FW	3000K	640	36°	SI Ø55	69,58 €
040155-T	8W	FW	4000K	640	36°	SI Ø55	69,58 €
040162-T	8W	FBK	2700K	640	36°	SI Ø55	69,58 €
040179-T	8W	FBK	3000K	640	36°	SI Ø55	69,58 €
040186-T	8W	FBK	4000K	640	36°	SI Ø55	69,58 €
0-10V							
040131-0	8W	FW	2700K	640	36°	SI Ø55	69,58 €
010148-0	8W	FW	3000K	640	36°	SI Ø55	69,58 €
040155-0	8W	FW	4000K	640	36°	SI Ø55	69,58 €
040162-0	8W	FBK	2700K	640	36°	SI Ø55	69,58 €
040179-0	8W	FBK	3000K	640	36°	SI Ø55	69,58 €
040186-0	8W	FBK	4000K	640	36°	SI Ø55	69,58 €
DALI/PUSH							
040131-D	8W	FW	2700K	640	36°	SI Ø55	69,58 €
010148-D	8W	FW	3000K	640	36°	SI Ø55	69,58 €
040155-D	8W	FW	4000K	640	36°	SI Ø55	69,58 €
040162-D	8W	FBK	2700K	640	36°	SI Ø55	69,58 €
040179-D	8W	FBK	3000K	640	36°	SI Ø55	69,58 €
040186-D	8W	FBK	4000K	640	36°	SI Ø55	69,58 €

KED743 12W IP44

REF.	POW.	ACABADO	CCT	LM	ANG.	OSCILANTE CUT (mm)	P.V.P.
041954	12W	FW	2700K	960	36°	SI Ø75	34,23 €
041961	12W	FW	3000K	960	36°	SI Ø75	34,23 €
041978	12W	FW	4000K	960	36°	SI Ø75	34,23 €
041985	12W	FBK	2700K	960	36°	SI Ø75	34,23 €
041992	12W	FBK	3000K	960	36°	SI Ø75	34,23 €
042005	12W	FBK	4000K	960	36°	SI Ø75	34,23 €

REGULACIONES/DIMMING

REF.	POW.	ACABADO	CCT	LM	ANG.	OSCILANTE CUT (mm)	P.V.P.
TRIAC							
041954-T	12W	FW	2700K	960	36°	SI Ø75	69,23 €
041961-T	12W	FW	3000K	960	36°	SI Ø75	69,23 €
041978-T	12W	FW	4000K	960	36°	SI Ø75	69,23 €
041985-T	12W	FBK	2700K	960	36°	SI Ø75	69,23 €
041992-T	12W	FBK	3000K	960	36°	SI Ø75	69,23 €
042005-T	12W	FBK	4000K	960	36°	SI Ø75	69,23 €
0-10V							
041954-0	12W	FW	2700K	960	36°	SI Ø75	69,23 €
041961-0	12W	FW	3000K	960	36°	SI Ø75	69,23 €
041978-0	12W	FW	4000K	960	36°	SI Ø75	69,23 €
041985-0	12W	FBK	2700K	960	36°	SI Ø75	69,23 €
041992-0	12W	FBK	3000K	960	36°	SI Ø75	69,23 €
042005-0	12W	FBK	4000K	960	36°	SI Ø75	69,23 €
DALI/PUSH							
041954-D	12W	FW	2700K	960	36°	SI Ø75	69,23 €
041961-D	12W	FW	3000K	960	36°	SI Ø75	69,23 €
041978-D	12W	FW	4000K	960	36°	SI Ø75	69,23 €
041985-D	12W	FBK	2700K	960	36°	SI Ø75	69,23 €
041992-D	12W	FBK	3000K	960	36°	SI Ø75	69,23 €
042005-D	12W	FBK	4000K	960	36°	SI Ø75	69,23 €

ÓPTICAS/OPTICS

REF.	DESCRIPCIÓN	P.V.P.
008414	C75-LENS 15°	1,10 €
008421	C75-LENS 24°	1,10 €
008603	C75-LENS 60°	1,10 €
008964	C75-LINEAL LENS	2,20 €
009053	C75-SIMPLE ASIMÉTRICA	2,20 €
009145	C75-DOBLE ASIMÉTRICA	2,20 €
009329	C75 PANEL DE ABEJA	2,20 €

*Panel de abeja solo disponible en IP44

KED743 12W IP65

REF.	POW.	ACABADO	CCT	LM	ANG.	OSCILANTE CUT (mm)	P.V.P.
042012	12W	FW	2700K	960	36°	SI Ø75	37,35 €
042029	12W	FW	3000K	960	36°	SI Ø75	37,35 €
042036	12W	FW	4000K	960	36°	SI Ø75	37,35 €
042043	12W	FBK	2700K	960	36°	SI Ø75	37,35 €
042050	12W	FBK	3000K	960	36°	SI Ø75	37,35 €
042067	12W	FBK	4000K	960	36°	SI Ø75	37,35 €

REGULACIONES/DIMMING

REF.	POW.	ACABADO	CCT	LM	ANG.	OSCILANTE CUT (mm)	P.V.P.
TRIAC							
042012-T	12W	FW	2700K	960	36°	SI Ø75	72,35 €
042029-T	12W	FW	3000K	960	36°	SI Ø75	72,35 €
042036-T	12W	FW	4000K	960	36°	SI Ø75	72,35 €
042043-T	12W	FBK	2700K	960	36°	SI Ø75	72,35 €
042050-T	12W	FBK	3000K	960	36°	SI Ø75	72,35 €
042067-T	12W	FBK	4000K	960	36°	SI Ø75	72,35 €
0-10V							
042012-0	12W	FW	2700K	960	36°	SI Ø75	72,35 €
042029-0	12W	FW	3000K	960	36°	SI Ø75	72,35 €
042036-0	12W	FW	4000K	960	36°	SI Ø75	72,35 €
042043-0	12W	FBK	2700K	960	36°	SI Ø75	72,35 €
042050-0	12W	FBK	3000K	960	36°	SI Ø75	72,35 €
042067-0	12W	FBK	4000K	960	36°	SI Ø75	72,35 €
DALI/PUSH							
042012-D	12W	FW	2700K	960	36°	SI Ø75	72,35 €
042029-D	12W	FW	3000K	960	36°	SI Ø75	72,35 €
042036-D	12W	FW	4000K	960	36°	SI Ø75	72,35 €
042043-D	12W	FBK	2700K	960	36°	SI Ø75	72,35 €
042050-D	12W	FBK	3000K	960	36°	SI Ø75	72,35 €
042067-D	12W	FBK	4000K	960	36°	SI Ø75	72,35 €

KED743 20W IP44

REF.	POW.	ACABADO	CCT	LM	ANG.	OSCILANTE CUT (mm)		P.V.P.
042074	20W	FW	2700K	1600	36°	SI	Ø95	56,56 €
042081	20W	FW	3000K	1600	36°	SI	Ø95	56,56 €
042098	20W	FW	4000K	1600	36°	SI	Ø95	56,56 €
042104	20W	FBK	2700K	1600	36°	SI	Ø95	56,56 €
042111	20W	FBK	3000K	1600	36°	SI	Ø95	56,56 €
042128	20W	FBK	4000K	1600	36°	SI	Ø95	56,56 €

REGULACIONES/DIMMING

REF.	POW.	ACABADO	CCT	LM	ANG.	OSCILANTE CUT (mm)		P.V.P.
TRIAC								
042074-T	20W	FW	2700K	1600	36°	SI	Ø95	91,56 €
042081-T	20W	FW	3000K	1600	36°	SI	Ø95	91,56 €
042098-T	20W	FW	4000K	1600	36°	SI	Ø95	91,56 €
042104-T	20W	FBK	2700K	1600	36°	SI	Ø95	91,56 €
042111-T	20W	FBK	3000K	1600	36°	SI	Ø95	91,56 €
042128-T	20W	FBK	4000K	1600	36°	SI	Ø95	91,56 €
0-10V								
042074-0	20W	FW	2700K	1600	36°	SI	Ø95	91,56 €
042081-0	20W	FW	3000K	1600	36°	SI	Ø95	91,56 €
042098-0	20W	FW	4000K	1600	36°	SI	Ø95	91,56 €
042104-0	20W	FBK	2700K	1600	36°	SI	Ø95	91,56 €
042111-0	20W	FBK	3000K	1600	36°	SI	Ø95	91,56 €
042128-0	20W	FBK	4000K	1600	36°	SI	Ø95	91,56 €
DALI/PUSH								
042074-D	20W	FW	2700K	1600	36°	SI	Ø95	91,56 €
042081-D	20W	FW	3000K	1600	36°	SI	Ø95	91,56 €
042098-D	20W	FW	4000K	1600	36°	SI	Ø95	91,56 €
042104-D	20W	FBK	2700K	1600	36°	SI	Ø95	91,56 €
042111-D	20W	FBK	3000K	1600	36°	SI	Ø95	91,56 €
042128-D	20W	FBK	4000K	1600	36°	SI	Ø95	91,56 €

ÓPTICAS/OPTICS

REF.	DESCRIPCIÓN	P.V.P.
012121	C95-LENS 15°	1,30 €
012220	C95-LENS 24°	1,30 €
012268	C95-LENS 60°	1,30 €
012305	C95-LINEAL LENS	2,50 €
012398	C95-SIMPLE ASIMÉTRICA	2,50 €
012510	C95-DOBLE ASIMÉTRICA	2,50 €
012886	C95 PANEL DE ABEJA	2,50 €

*Panel de abeja solo disponible en IP44

KED743 20W IP65

REF.	POW.	ACABADO	CCT	LM	ANG.	OSCILANTE CUT (mm)	P.V.P.
042135	20W	FW	2700K	1600	36°	SI Ø95	59,69 €
042142	20W	FW	3000K	1600	36°	SI Ø95	59,69 €
042159	20W	FW	4000K	1600	36°	SI Ø95	59,69 €
042166	20W	FBK	2700K	1600	36°	SI Ø95	59,69 €
042173	20W	FBK	3000K	1600	36°	SI Ø95	59,69 €
042180	20W	FBK	4000K	1600	36°	SI Ø95	59,69 €

REGULACIONES/DIMMING

REF.	POW.	ACABADO	CCT	LM	ANG.	OSCILANTE CUT (mm)	P.V.P.
TRIAC							
042135-T	20W	FW	2700K	1600	36°	SI Ø95	94,69 €
042142-T	20W	FW	3000K	1600	36°	SI Ø95	94,69 €
042159-T	20W	FW	4000K	1600	36°	SI Ø95	94,69 €
042166-T	20W	FBK	2700K	1600	36°	SI Ø95	94,69 €
042173-T	20W	FBK	3000K	1600	36°	SI Ø95	94,69 €
042180-T	20W	FBK	4000K	1600	36°	SI Ø95	94,69 €
0-10V							
042135-0	20W	FW	2700K	1600	36°	SI Ø95	94,69 €
042142-0	20W	FW	3000K	1600	36°	SI Ø95	94,69 €
042159-0	20W	FW	4000K	1600	36°	SI Ø95	94,69 €
042166-0	20W	FBK	2700K	1600	36°	SI Ø95	94,69 €
042173-0	20W	FBK	3000K	1600	36°	SI Ø95	94,69 €
042180-0	20W	FBK	4000K	1600	36°	SI Ø95	94,69 €
DALI/PUSH							
042135-D	20W	FW	2700K	1600	36°	SI Ø95	94,69 €
042142-D	20W	FW	3000K	1600	36°	SI Ø95	94,69 €
042159-D	20W	FW	4000K	1600	36°	SI Ø95	94,69 €
042166-D	20W	FBK	2700K	1600	36°	SI Ø95	94,69 €
042173-D	20W	FBK	3000K	1600	36°	SI Ø95	94,69 €
042180-D	20W	FBK	4000K	1600	36°	SI Ø95	94,69 €

ACCESORIOS KED743 8W IP44

REF.	DESCRIPCIÓN	P.V.P.
006052	C55- REDONDO TRIMLESS	1,50 €
006083	C55- CUADRADO TRIMLESS	2,00 €
006113	C55- CUADRADO DOBLE TRIMLESS FW	4,00 €
006168	C55- ANILLO REDONDO FW	1,50 €
006328	C55- CUADRADO FW	2,00 €
006342	C55-CUADRADO DOBLE FW	4,00 €
006441	C55- ANILLO REDONDO FBK	1,50 €
006465	C55- CUADRADO FBK	2,00 €
006472	C55-CUADRADO DOBLE FBK	4,00 €
006533	C55- REFLECTOR BLANCO MATE	1,15 €
006632	C55- REFLECTOR NEGRO MATE	1,15 €
006663	C55- REFLECTOR GUN BLACK	1,15 €
006748	C55- REFLECTOR ROSE GOLD	1,15 €
006779	C55- REFLECTOR SILVER	1,15 €
006793	C55- REFLECTOR CHROME	1,15 €
006809	C55- REFLECTOR OVAL BLANCO MATE	1,50 €
006830	C55- REFLECTOR REDONDO BLANCO MATE	1,50 €
006854	C55- REFLECTOR POLARIZANTE	1,50 €
006861	C55- REFLECTOR WALL WASHER BLANCO MATE	1,50 €
006885	C55- REFLECTOR WALL WASHER NEGRO MATE	1,50 €

ACCESORIOS KED743 12W IP44

REF.	DESCRIPCIÓN	P.V.P.
007318	C75- REDONDO TRIMLESS	2,00 €
007400	C75- CUADRADO TRIMLESS	2,50 €
007455	C75- CUADRADO DOBLE TRIMLESS FW	4,50 €
007486	C75- ANILLO REDONDO FW	2,00 €
007516	C75- CUADRADO FW	2,50 €
007523	C75-CUADRADO DOBLE FW	4,50 €
007547	C75- ANILLO REDONDO FBK	2,00 €
007578	C75- CUADRADO FBK	2,50 €
007608	C75-CUADRADO DOBLE FBK	4,50 €
007615	C75- REFLECTOR BLANCO MATE	1,30 €
007639	C75- REFLECTOR NEGRO MATE	1,30 €
007660	C75- REFLECTOR GUN BLACK	1,30 €
007691	C75- REFLECTOR ROSE GOLD	1,30 €
007783	C75- REFLECTOR SILVER	1,30 €
007875	C75- REFLECTOR CHROME	1,30 €
007967	C75- REFLECTOR OVAL BLANCO MATE	2,00 €
008292	C75- REFLECTOR REDONDO BLANCO MATE	2,00 €
008322	C75- REFLECTOR POLARIZANTE	2,00 €
008353	C75- REFLECTOR WALL WASHER BLANCO MATE	2,00 €
008384	C75- REFLECTOR WALL WASHER NEGRO MATE	2,00 €

ACCESORIOS KED743 20W IP44

REF.	DESCRIPCIÓN	P.V.P.
009800	C95- REDONDO TRIMLESS	2,50 €
009978	C95- CUADRADO TRIMLESS	3,00 €
009985	C95- CUADRADO DOBLE TRIMLESS FW	5,00 €
010004	C95- ANILLO REDONDO FW	2,50 €
010011	C95- CUADRADO FW	3,00 €
010028	C95-CUADRADO DOBLE FW	5,00 €
010035	C95- ANILLO REDONDO FBK	2,50 €
010202	C95- CUADRADO FBK	3,00 €
010349	C95-CUADRADO DOBLE FBK	5,00 €
010684	C95- REFLECTOR BLANCO MATE	1,50 €
010707	C95- REFLECTOR NEGRO MATE	1,50 €
010714	C95- REFLECTOR GUN BLACK	1,50 €
010776	C95- REFLECTOR ROSE GOLD	1,50 €
010806	C95- REFLECTOR SILVER	1,50 €
010844	C95- REFLECTOR CHROME	1,50 €
011391	C95- REFLECTOR OVAL BLANCO MATE	2,50 €
011490	C95- REFLECTOR REDONDO BLANCO MATE	2,50 €
011544	C95- REFLECTOR POLARIZANTE	2,50 €
011704	C95- REFLECTOR WALL WASHER BLANCO MATE	2,50 €
011766	C95- REFLECTOR WALL WASHER NEGRO MATE	2,50 €

SERIES MINI CCT



SELECTOR CCT
Sistema para elegir la temperatura de color mediante interruptor. Permite seleccionar entre blanco cálido (3000K), neutro (4000K) y frío (5000K).



DIMENSIONES DIMENSIONS

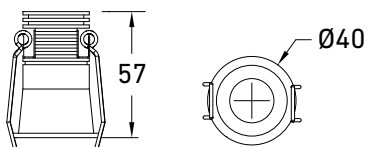

FOTOMETRÍA PHOTOMETRY

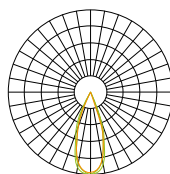

ACABADOS FINISHES



REGULACIÓN DIMMING

TRIAC - 0-10V - DALI

* CASAMBI A CONSULTAR

ACCESORIOS ACCESSORIES



SERIES MINI CCT - LC246 - 6W

REF.	POW.	ACABADO	CCT	LM	ANG.	OSCILANTE CUT (mm)	P.V.P.
034888	6W	FW	3000K 4000K	410	38	NO Ø35	18,35 €
034895	6W	FBK	3000K 4000K	410	38	NO Ø35	18,35 €
040193	6W	FW	2700K	410	38	NO Ø35	16,90 €
040209	6W	FBK	2700K	410	38	NO Ø35	16,90 €
042685	6W	FW	3000K	410	38	NO Ø35	16,90 €
042692	6W	FBK	3000K	410	38	NO Ø35	16,90 €
042708	6W	FW	4000k	410	38	NO Ø35	16,90 €
042715	6W	FBK	4000k	410	38	NO Ø35	16,90 €

REGULACIONES/DIMMING

REF.	POW.	ACABADO	CCT	LM	ANG.	OSCILANTE CUT (mm)	P.V.P.
TRIAC							
040193-T	6W	FW	2700K	410	38	NO Ø35	51,90 €
040209-T	6W	FBK	2700K	410	38	NO Ø35	51,90 €
042685-T	6W	FW	3000K	410	38	NO Ø35	51,90 €
042692-T	6W	FBK	3000K	410	38	NO Ø35	51,90 €
042708-T	6W	FW	4000k	410	38	NO Ø35	51,90 €
042715-T	6W	FBK	4000k	410	38	NO Ø35	51,90 €
0-10V							
040193-0	6W	FW	2700K	410	38	NO Ø35	51,90 €
040209-0	6W	FBK	2700K	410	38	NO Ø35	51,90 €
042685-0	6W	FW	3000K	410	38	NO Ø35	51,90 €
042692-0	6W	FBK	3000K	410	38	NO Ø35	51,90 €
042708-0	6W	FW	4000k	410	38	NO Ø35	51,90 €
042715-0	6W	FBK	4000k	410	38	NO Ø35	51,90 €
DALI/PUSH							
040193-D	6W	FW	2700K	410	38	NO Ø35	51,90 €
040209-D	6W	FBK	2700K	410	38	NO Ø35	51,90 €
042685-D	6W	FW	3000K	410	38	NO Ø35	51,90 €
042692-D	6W	FBK	3000K	410	38	NO Ø35	51,90 €
042708-D	6W	FW	4000k	410	38	NO Ø35	51,90 €
042715-D	6W	FBK	4000k	410	38	NO Ø35	51,90 €

ACCESORIOS/ACCESSORIES

REF.	DESCRIPCIÓN	P.V.P.
013012	COFFE	2,00 €
013043	GOLD	2,00 €
014286	BK	2,00 €
014293	ANTIQUE BRONZE	2,00 €
014545	BU	2,00 €
015023	RED	2,00 €
015030	CHROME PLATE	2,00 €

ÓPTICAS/OPTICS

REF.	DESCRIPCIÓN	P.V.P.
015078	LENS 15°	0,90 €
016259	LENS 24°	0,90 €

SERIES MINI RING



SELECTOR CCT
 Sistema para elegir la temperatura de color mediante interruptor. Permite seleccionar entre blanco cálido (3000K), neutro (3500K) y frío (4000K).

Al

6W

AC
100V
240V

CCT
3000K/3500K
4000K

2.700°K

3.000°K

3.500°K

4.000°K

15°

24°

38°

Ø45mm

35.000h

NO FLICKERING

Hz
50/60



IP 20
RATED

CRI
>90

RoHS
COMPLIANT



3 AÑOS
GARANTÍA

DIMENSIONES DIMENSIONS

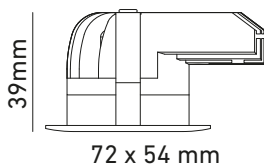

FOTOMETRÍA PHOTOMETRY

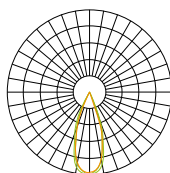

ACABADOS FINISHES



REGULACIÓN DIMMING

TRIAC - 0-10V - DALI

* CASAMBI A CONSULTAR

ACCESORIOS ACCESSORIES

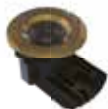

SERIES MINI RING - LC3154 - 6W

REF.	POW.	ACABADO	CCT	LM	ANG.	OSCILANTE CUT (mm)	P.V.P
038169	6W	FW	3000K 3500K 4000K	540	38°	NO Ø45	20,45 €
042746	6W	FW	2700k	540	38°	NO Ø45	18,90 €
042753	6W	FW	3000K	540	38°	NO Ø45	18,90 €
042760	6W	FW	4000K	540	38°	NO Ø45	18,90 €

REGULACIONES/DIMMING

REF.	POW.	ACABADO	CCT	LM	ANG.	OSCILANTE CUT (mm)	P.V.P
TRIAC							
042777-T	6W	FW	2700K	540	38°	NO Ø45	53,90 €
042784-T	6W	FW	3000K	540	38°	NO Ø45	53,90 €
042791-T	6W	FW	4000K	540	38°	NO Ø45	53,90 €
0-10V							
042807-0	6W	FW	2700K	540	38°	NO Ø45	53,90 €
042814-0	6W	FW	3000K	540	38°	NO Ø45	53,90 €
042821-0	6W	FW	4000K	540	38°	NO Ø45	53,90 €
DALI/PUSH							
042838-D	6W	FW	2700K	540	38°	NO Ø45	53,90 €
042845-D	6W	FW	3000K	540	38°	NO Ø45	53,90 €
042852-D	6W	FW	4000K	540	38°	NO Ø45	53,90 €

ACCESORIOS/ACCESSORIES

REF.	DESCRIPCIÓN	P.V.P.
038183	FBK-RING	2,67 €
038190	CH-RING	3,12 €
038206	G-RING	3,12 €
038213	BU-RING	3,12 €
038220	P-RING	3,12 €

ÓPTICAS/OPTICS

REF.	DESCRIPCIÓN	P.V.P.
038237	LENS 15°	0,90 €
038244	LENS 24°	0,90 €

SERIES SMALL CUT



Al	5W	8W	12W	300 LUMEN	550 LUMEN	840 LUMEN	2.700°K	3.000°K	4.000°K	15°	24°	36°	AC 200V 240V	Hz 50/60
Ø25mm	Ø35mm	Ø45mm	IP20 RATED	NO FLICKERING	CRI >95	PF >0.9	RoHS COMPLIANT		5 AÑOS GARANTÍA					

DIMENSIONES DIMENSIONS

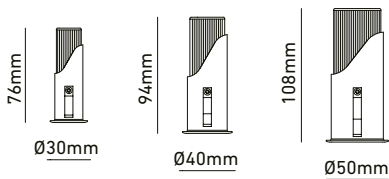

FOTOMETRÍA PHOTOMETRY

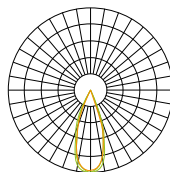

ACABADOS FINISHES



REGULACIÓN DIMMING

TRIAC - 0-10V - DALI

* CASAMBI A CONSULTAR

SERIES SMALL CUT - LC3255 - 5W

REF.	POW.	ACABADO	CCT	LM	ANG.	OSCILANTE CUT (mm)	P.V.P
040216	5W	FW	2700K	300	36	NO Ø25	28,97 €
040223	5W	FW	3000K	300	36	NO Ø25	28,97 €
040230	5W	FW	4000K	300	36	NO Ø25	28,97 €
040247	5W	FBK	2700K	300	36	NO Ø25	28,97 €
040254	5W	FBK	3000K	300	36	NO Ø25	28,97 €
040261	5W	FBK	4000K	300	36	NO Ø25	28,97 €

REGULACIONES/DIMMING

REF.	POW.	ACABADO	CCT	LM	ANG.	OSCILANTE CUT (mm)	P.V.P
TRIAC							
040216-T	5W	FW	2700K	300	36	NO Ø25	63,97 €
040223-T	5W	FW	3000K	300	36	NO Ø25	63,97 €
040230-T	5W	FW	4000K	300	36	NO Ø25	63,97 €
040247-T	5W	FBK	2700K	300	36	NO Ø25	63,97 €
040254-T	5W	FBK	3000K	300	36	NO Ø25	63,97 €
040261-T	5W	FBK	4000K	300	36	NO Ø25	63,97 €
0-10V							
040216-0	5W	FW	2700K	300	36	NO Ø25	63,97 €
040223-0	5W	FW	3000K	300	36	NO Ø25	63,97 €
040230-0	5W	FW	4000K	300	36	NO Ø25	63,97 €
040247-0	5W	FBK	2700K	300	36	NO Ø25	63,97 €
040254-0	5W	FBK	3000K	300	36	NO Ø25	63,97 €
040261-0	5W	FBK	4000K	300	36	NO Ø25	63,97 €
DALI/PUSH							
040216-D	5W	FW	2700K	300	36	NO Ø25	63,97 €
040223-D	5W	FW	3000K	300	36	NO Ø25	63,97 €
040230-D	5W	FW	4000K	300	36	NO Ø25	63,97 €
040247-D	5W	FBK	2700K	300	36	NO Ø25	63,97 €
040254-D	5W	FBK	3000K	300	36	NO Ø25	63,97 €
040261-D	5W	FBK	4000K	300	36	NO Ø25	63,97 €

ACCESORIOS/ACCESSORIES

REF.	DESCRIPCIÓN	P.V.P
022939	FBK-REFLECTOR	2,00 €

ÓPTICAS/OPTICS

REF.	DESCRIPCIÓN	P.V.P
016341	LENS 15°	0,90 €
017041	LENS 24°	0,90 €
017492	LENS 60°	0,90 €

SERIES SMALL CUT - LC3255 - 8W

REF.	POW.	ACABADO	CCT	LM	ANG.	OSCILANTE CUT (mm)	P.V.P
040278	8W	FW	2700K	550	36	NO Ø35	33,53 €
040285	8W	FW	3000K	550	36	NO Ø35	33,53 €
040292	8W	FW	4000K	550	36	NO Ø35	33,53 €
040308	8W	FBK	2700K	550	36	NO Ø35	33,53 €
040315	8W	FBK	3000K	550	36	NO Ø35	33,53 €
040322	8W	FBK	4000K	550	36	NO Ø35	33,53 €

REGULACIONES/DIMMING

REF.	POW.	ACABADO	CCT	LM	ANG.	OSCILANTE CUT (mm)	P.V.P
TRIAC							
040278-T	8W	FW	2700K	550	36	NO Ø35	68,58 €
040285-T	8W	FW	3000K	550	36	NO Ø35	68,58 €
040292-T	8W	FW	4000K	550	36	NO Ø35	68,58 €
040308-T	8W	FBK	2700K	550	36	NO Ø35	68,58 €
040315-T	8W	FBK	3000K	550	36	NO Ø35	68,58 €
040322-T	8W	FBK	4000K	550	36	NO Ø35	68,58 €
0-10V							
040278-0	8W	FW	2700K	550	36	NO Ø35	68,58 €
040285-0	8W	FW	3000K	550	36	NO Ø35	68,58 €
040292-0	8W	FW	4000K	550	36	NO Ø35	68,58 €
040308-0	8W	FBK	2700K	550	36	NO Ø35	68,58 €
040315-0	8W	FBK	3000K	550	36	NO Ø35	68,58 €
040322-0	8W	FBK	4000K	550	36	NO Ø35	68,58 €
DALI/PUSH							
040278-D	8W	FW	2700K	550	36	NO Ø35	68,58 €
040285-D	8W	FW	3000K	550	36	NO Ø35	68,58 €
040292-D	8W	FW	4000K	550	36	NO Ø35	68,58 €
040308-D	8W	FBK	2700K	550	36	NO Ø35	68,58 €
040315-D	8W	FBK	3000K	550	36	NO Ø35	68,58 €
040322-D	8W	FBK	4000K	550	36	NO Ø35	68,58 €

ACCESORIOS/ACCESSORIES

REF.	DESCRIPCIÓN	P.V.P.
------	-------------	--------

ÓPTICAS/OPTICS

REF.	DESCRIPCIÓN	P.V.P.
017553	LENS 15°	1,20 €
017621	LENS 24°	1,20 €
017645	LENS 60°	1,20 €

SERIES SMALL CUT - LC3255 - 12W

REF.	POW.	ACABADO	CCT	LM	ANG.	OSCILANTE CUT (mm)	P.V.P
040339	12W	FW	2700K	840	36	NO Ø45	38,88 €
040346	12W	FW	3000K	840	36	NO Ø45	38,88 €
040353	12W	FW	4000K	840	36	NO Ø45	38,88 €
040360	12W	FBK	2700K	840	36	NO Ø45	38,88 €
040377	12W	FBK	3000K	840	36	NO Ø45	38,88 €
040384	12W	FBK	4000K	840	36	NO Ø45	38,88 €

REGULACIONES/DIMMING

REF.	POW.	ACABADO	CCT	LM	ANG.	OSCILANTE CUT (mm)	P.V.P
TRIAC							
040339-T	12W	FW	2700K	840	36	NO Ø45	73,88 €
040346-T	12W	FW	3000K	840	36	NO Ø45	73,88 €
040353-T	12W	FW	4000K	840	36	NO Ø45	73,88 €
040360-T	12W	FBK	2700K	840	36	NO Ø45	73,88 €
040377-T	12W	FBK	3000K	840	36	NO Ø45	73,88 €
040384-T	12W	FBK	4000K	840	36	NO Ø45	73,88 €
0-10V							
040339-0	12W	FW	2700K	840	36	NO Ø45	73,88 €
040346-0	12W	FW	3000K	840	36	NO Ø45	73,88 €
040353-0	12W	FW	4000K	840	36	NO Ø45	73,88 €
040360-0	12W	FBK	2700K	840	36	NO Ø45	73,88 €
040377-0	12W	FBK	3000K	840	36	NO Ø45	73,88 €
040384-0	12W	FBK	4000K	840	36	NO Ø45	73,88 €
DALI/PUSH							
040339-D	12W	FW	2700K	840	36	NO Ø45	73,88 €
040346-D	12W	FW	3000K	840	36	NO Ø45	73,88 €
040353-D	12W	FW	4000K	840	36	NO Ø45	73,88 €
040360-D	12W	FBK	2700K	840	36	NO Ø45	73,88 €
040377-D	12W	FBK	3000K	840	36	NO Ø45	73,88 €
040384-D	12W	FBK	4000K	840	36	NO Ø45	73,88 €

ACCESORIOS/ACCESSORIES

REF.	DESCRIPCIÓN	P.V.P.
------	-------------	--------

ÓPTICAS/OPTICS

REF.	DESCRIPCIÓN	P.V.P.
017652	LENS 15°	1,50 €
017676	LENS 24°	1,50 €
017690	LENS 60°	1,50 €

SERIES SMALL CUT - TRIMLESS



Al	5W	8W	12W	300 LUMEN	550 LUMEN	840 LUMEN	2.700°K	3.000°K	4.000°K	15°	24°	36°	AC 200V 240V	Hz 50/60
Ø35mm	Ø45mm	Ø55mm	IP20 RATED	NO FLICKERING	CRI >95	PF >0.9	RoHS COMPLIANT		5 AÑOS GARANTÍA					

DIMENSIONES DIMENSIONS

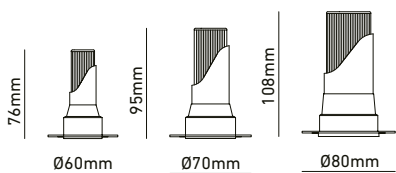

FOTOMETRÍA PHOTOMETRY

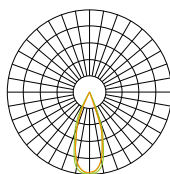

ACABADOS FINISHES



REGULACIÓN DIMMING

TRIAC - 0-10V - DALI

* CASAMBI A CONSULTAR

ACCESORIOS ACCESSORIES



SERIES SMALL CUT - TRIMLESS - LC3265 - 5W

REF.	POW.	ACABADO	CCT	LM	ANG.	OSCILANTE CUT (mm)	P.V.P
040391	5W	FW	2700K	300	36	NO Ø25	30,42 €
040407	5W	FW	3000K	300	36	NO Ø25	30,42 €
040414	5W	FW	4000K	300	36	NO Ø25	30,42 €
040421	5W	FBK	2700K	300	36	NO Ø25	30,42 €
040438	5W	FBK	3000K	300	36	NO Ø25	30,42 €
040445	5W	FBK	4000K	300	36	NO Ø25	30,42 €

REGULACIONES/DIMMING

REF.	POW.	ACABADO	CCT	LM	ANG.	OSCILANTE CUT (mm)	P.V.P
TRIAC							
040391-T	5W	FW	2700K	300	36	NO Ø35	65,42 €
040407-T	5W	FW	3000K	300	36	NO Ø35	65,42 €
040414-T	5W	FW	4000K	300	36	NO Ø35	65,42 €
040421-T	5W	FBK	2700K	300	36	NO Ø35	65,42 €
040438-T	5W	FBK	3000K	300	36	NO Ø35	65,42 €
040445-T	5W	FBK	4000K	300	36	NO Ø35	65,42 €
0-10V							
040391-0	5W	FW	2700K	300	36	NO Ø35	65,42 €
040407-0	5W	FW	3000K	300	36	NO Ø35	65,42 €
040414-0	5W	FW	4000K	300	36	NO Ø35	65,42 €
040421-0	5W	FBK	2700K	300	36	NO Ø35	65,42 €
040438-0	5W	FBK	3000K	300	36	NO Ø35	65,42 €
040445-0	5W	FBK	4000K	300	36	NO Ø35	65,42 €
DALI/PUSH							
040391-D	5W	FW	2700K	300	36	NO Ø35	65,42 €
040407-D	5W	FW	3000K	300	36	NO Ø35	65,42 €
040414-D	5W	FW	4000K	300	36	NO Ø35	65,42 €
040421-D	5W	FBK	2700K	300	36	NO Ø35	65,42 €
040438-D	5W	FBK	3000K	300	36	NO Ø35	65,42 €
040445-D	5W	FBK	4000K	300	36	NO Ø35	65,42 €

ACCESORIOS/ACCESSORIES

REF.	DESCRIPCIÓN	P.V.P.
017829	C35-TRIMLESS	0,90 €

ÓPTICAS/OPTICS

REF.	DESCRIPCIÓN	P.V.P.
017836	LENS 15°	0,90 €
017942	LENS 24°	0,90 €
019335	LENS 60°	0,90 €

SERIES SMALL CUT - TRIMLESS - LC3265 - 8W

REF.	POW.	ACABADO	CCT	LM	ANG.	OSCILANTE CUT (mm)	P.V.P
040452	8W	FW	2700K	550	36	NO Ø35	36,81 €
040469	8W	FW	3000K	550	36	NO Ø35	36,81 €
040476	8W	FW	4000K	550	36	NO Ø35	36,81 €
040483	8W	FBK	2700K	550	36	NO Ø35	36,81 €
040490	8W	FBK	3000K	550	36	NO Ø35	36,81 €
040506	8W	FBK	4000K	550	36	NO Ø35	36,81 €

REGULACIONES/DIMMING

REF.	POW.	ACABADO	CCT	LM	ANG.	OSCILANTE CUT (mm)	P.V.P.
TRIAC							
040452-T	8W	FW	2700K	550	36	NO Ø45	71,81 €
040469-T	8W	FW	3000K	550	36	NO Ø45	71,81 €
040476-T	8W	FW	4000K	550	36	NO Ø45	71,81 €
040483-T	8W	FBK	2700K	550	36	NO Ø45	71,81 €
040490-T	8W	FBK	3000K	550	36	NO Ø45	71,81 €
040506-T	8W	FBK	4000K	550	36	NO Ø45	71,81 €
0-10V							
040452-0	8W	FW	2700K	550	36	NO Ø45	71,81 €
040469-0	8W	FW	3000K	550	36	NO Ø45	71,81 €
040476-0	8W	FW	4000K	550	36	NO Ø45	71,81 €
040483-0	8W	FBK	2700K	550	36	NO Ø45	71,81 €
040490-0	8W	FBK	3000K	550	36	NO Ø45	71,81 €
040506-0	8W	FBK	4000K	550	36	NO Ø45	71,81 €
DALI/PUSH							
040452-D	8W	FW	2700K	550	36	NO Ø45	71,81 €
040469-D	8W	FW	3000K	550	36	NO Ø45	71,81 €
040476-D	8W	FW	4000K	550	36	NO Ø45	71,81 €
040483-D	8W	FBK	2700K	550	36	NO Ø45	71,81 €
040490-D	8W	FBK	3000K	550	36	NO Ø45	71,81 €
040506-D	8W	FBK	4000K	550	36	NO Ø45	71,81 €

ACCESORIOS/ACCESSORIES

REF.	DESCRIPCIÓN	P.V.P.
019755	C45-TRIMLESS	1,20 €

ÓPTICAS/OPTICS

REF.	DESCRIPCIÓN	P.V.P.
019816	LENS 15°	1,20 €
019915	LENS 24°	1,20 €
019960	LENS 60°	1,20 €

SERIES SMALL CUT - TRIMLESS - LC3265 - 12W

REF.	POW.	ACABADO	CCT	LM	ANG.	OSCILANTE CUT (mm)	P.V.P
040513	12W	FW	2700K	840	36	NO Ø45	42,73 €
040520	12W	FW	3000K	840	36	NO Ø45	42,73 €
040537	12W	FW	4000K	840	36	NO Ø45	42,73 €
040544	12W	FBK	2700K	840	36	NO Ø45	42,73 €
040551	12W	FBK	3000K	840	36	NO Ø45	42,73 €
040568	12W	FBK	4000K	840	36	NO Ø45	42,73 €

REGULACIONES/DIMMING

REF.	POW.	ACABADO	CCT	LM	ANG.	OSCILANTE CUT (mm)	P.V.P
TRIAC							
040513-T	12W	FW	2700K	840	36	NO Ø55	77,73 €
040520-T	12W	FW	3000K	840	36	NO Ø55	77,73 €
040537-T	12W	FW	4000K	840	36	NO Ø55	77,73 €
040544-T	12W	FBK	2700K	840	36	NO Ø55	77,73 €
040551-T	12W	FBK	3000K	840	36	NO Ø55	77,73 €
040568-T	12W	FBK	4000K	840	36	NO Ø55	77,73 €
0-10V							
040513-0	12W	FW	2700K	840	36	NO Ø55	77,73 €
040520-0	12W	FW	3000K	840	36	NO Ø55	77,73 €
040537-0	12W	FW	4000K	840	36	NO Ø55	77,73 €
040544-0	12W	FBK	2700K	840	36	NO Ø55	77,73 €
040551-0	12W	FBK	3000K	840	36	NO Ø55	77,73 €
040568-0	12W	FBK	4000K	840	36	NO Ø55	77,73 €
DALI/PUSH							
040513-D	12W	FW	2700K	840	36	NO Ø55	77,73 €
040520-D	12W	FW	3000K	840	36	NO Ø55	77,73 €
040537-D	12W	FW	4000K	840	36	NO Ø55	77,73 €
040544-D	12W	FBK	2700K	840	36	NO Ø55	77,73 €
040551-D	12W	FBK	3000K	840	36	NO Ø55	77,73 €
040568-D	12W	FBK	4000K	840	36	NO Ø55	77,73 €

ACCESORIOS/ACCESSORIES

REF.	DESCRIPCIÓN	P.V.P.
019991	C55-TRIMLESS	1,50 €

ÓPTICAS/OPTICS

REF.	DESCRIPCIÓN	P.V.P.
020003	LENS 15°	1,50 €
020010	LENS 24°	1,50 €
020034	LENS 60°	1,50 €

SERIES MINIMALIST



Al **8W** **12W** **450 LUMEN** **700 LUMEN** **2.700°K** **3.000°K** **4.000°K** **24°** **36°** **Ø35mm** **Ø45mm** **AC 200V 240V** **Hz 50/60** **IP20 RATED**
NO FLICKERING **CRI >95** **PF >0.9** **RoHS COMPLIANT** **CE** **5 AÑOS GARANTÍA**

DIMENSIONES DIMENSIONS

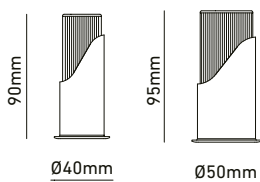

ACABADOS FINISHES



FOTOMETRÍA PHOTOMETRY

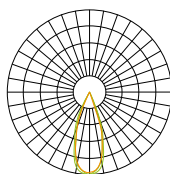

REGULACIÓN DIMMING

TRIAC - 0-10V - DALI

* CASAMBI A CONSULTAR

SERIES MINIMALIST - LC3298 - 8W

REF.	POW.	ACABADO	CCT	LM	ANG.	OSCILANTE CUT (mm)	P.V.P
040575	8W	FW	2700K	450	36	NO Ø45	31,57 €
040582	8W	FW	3000K	450	36	NO Ø45	31,57 €
040599	8W	FW	4000K	450	36	NO Ø45	31,57 €
040605	8W	FBK	2700K	450	36	NO Ø45	31,57 €
040612	8W	FBK	3000K	450	36	NO Ø45	31,57 €
040629	8W	FBK	4000K	450	36	NO Ø45	31,57 €

REGULACIONES/DIMMING

REF.	POW.	ACABADO	CCT	LM	ANG.	OSCILANTE CUT (mm)	P.V.P.
TRIAC							
040575-T	8W	FW	2700K	450	36	NO Ø45	66,57 €
040582-T	8W	FW	3000K	450	36	NO Ø45	66,57 €
040599-T	8W	FW	4000K	450	36	NO Ø45	66,57 €
040605-T	8W	FBK	2700K	450	36	NO Ø45	66,57 €
040612-T	8W	FBK	3000K	450	36	NO Ø45	66,57 €
040629-T	8W	FBK	4000K	450	36	NO Ø45	66,57 €
0-10V							
040575-0	8W	FW	2700K	450	36	NO Ø45	66,57 €
040582-0	8W	FW	3000K	450	36	NO Ø45	66,57 €
040599-0	8W	FW	4000K	450	36	NO Ø45	66,57 €
040605-0	8W	FBK	2700K	450	36	NO Ø45	66,57 €
040612-0	8W	FBK	3000K	450	36	NO Ø45	66,57 €
040629-0	8W	FBK	4000K	450	36	NO Ø45	66,57 €
DALI/PUSH							
040575-D	8W	FW	2700K	450	36	NO Ø45	66,57 €
040582-D	8W	FW	3000K	450	36	NO Ø45	66,57 €
040599-D	8W	FW	4000K	450	36	NO Ø45	66,57 €
040605-D	8W	FBK	2700K	450	36	NO Ø45	66,57 €
040612-D	8W	FBK	3000K	450	36	NO Ø45	66,57 €
040629-D	8W	FBK	4000K	450	36	NO Ø45	66,57 €

ACCESORIOS/ACCESSORIES

REF.	DESCRIPCIÓN	P.V.P.
020041	C45 FW	1,20 €
020072	C45 FBK	1,20 €
020096	C45 ANTIQUE BRONZE	1,20 €
020102	C45 GOLD	1,20 €

ÓPTICAS/OPTICS

REF.	DESCRIPCIÓN	P.V.P.
020126	LENS 24°	1,20 €

SERIES MINIMALIST - LC3298 - 12W

REF.	POW.	ACABADO	CCT	LM	ANG.	OSCILANTE CUT (mm)	P.V.P
040636	12W	FW	2700K	700	36	NO Ø55	
040643	12W	FW	3000K	700	36	NO Ø55	
040650	12W	FW	4000K	700	36	NO Ø55	
040667	12W	FBK	2700K	700	36	NO Ø55	
040674	12W	FBK	3000K	700	36	NO Ø55	
040681	12W	FBK	4000K	700	36	NO Ø55	

REGULACIONES/DIMMING

REF.	POW.	ACABADO	CCT	LM	ANG.	OSCILANTE CUT (mm)	P.V.P
TRIAC							
040636-T	12W	FW	2700K	700	36	NO Ø55	
040643-T	12W	FW	3000K	700	36	NO Ø55	
040650-T	12W	FW	4000K	700	36	NO Ø55	
040667-T	12W	FBK	2700K	700	36	NO Ø55	
040674-T	12W	FBK	3000K	700	36	NO Ø55	
040681-T	12W	FBK	4000K	700	36	NO Ø55	
0-10V							
040636-0	12W	FW	2700K	700	36	NO Ø55	
040643-0	12W	FW	3000K	700	36	NO Ø55	
040650-0	12W	FW	4000K	700	36	NO Ø55	
040667-0	12W	FBK	2700K	700	36	NO Ø55	
040674-0	12W	FBK	3000K	700	36	NO Ø55	
040681-0	12W	FBK	4000K	700	36	NO Ø55	
DALI/PUSH							
040636-D	12W	FW	2700K	700	36	NO Ø55	
040643-D	12W	FW	3000K	700	36	NO Ø55	
040650-D	12W	FW	4000K	700	36	NO Ø55	
040667-D	12W	FBK	2700K	700	36	NO Ø55	
040674-D	12W	FBK	3000K	700	36	NO Ø55	
040681-D	12W	FBK	4000K	700	36	NO Ø55	

ACCESORIOS/ACCESSORIES

REF.	DESCRIPCIÓN	P.V.P.
020133	C55 FW	1,50 €
020157	C55 FBK	1,50 €
020164	C55 ANTIQUE BRONZE	1,50 €
020188	C55 GOLD	1,50 €

ÓPTICAS/OPTICS

REF.	DESCRIPCIÓN	P.V.P.
020683	LENS 24°	1,50 €

SERIES MINIMALIST - TRIMLESS



Al **8W** **12W** **450 LUMEN** **700 LUMEN** **2.700°K** **3.000°K** **4.000°K** **24°** **36°** **Ø45mm** **Ø55mm** **AC 200V 240V** **Hz 50/60** **IP20 RATED**
NO FLICKERING **CRI >95** **PF >0.9** **RoHS COMPLIANT** **CE** **5 AÑOS GARANTÍA**

DIMENSIONES DIMENSIONS

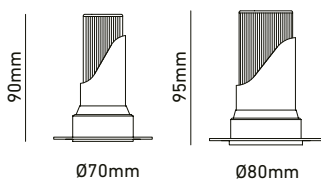

FOTOMETRÍA PHOTOMETRY

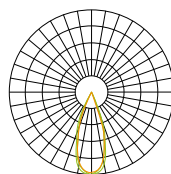

ACABADOS FINISHES



REGULACIÓN DIMMING

TRIAC - 0-10V - DALI

* CASAMBI A CONSULTAR

ACCESORIOS ACCESSORIES



SERIES MINIMALIST - TRIMLESS - LC3298 - 8W

REF.	POW.	ACABADO	CCT	LM	ANG.	OSCILANTE CUT (mm)	P.V.P
040698	8W	FW	2700K	450	36	NO Ø45	35,82 €
040704	8W	FW	3000K	450	36	NO Ø45	35,82 €
040711	8W	FW	4000K	450	36	NO Ø45	35,82 €
040728	8W	FBK	2700K	450	36	NO Ø45	35,82 €
040735	8W	FBK	3000K	450	36	NO Ø45	35,82 €
040742	8W	FBK	4000K	450	36	NO Ø45	35,82 €

REGULACIONES/DIMMING

REF.	POW.	ACABADO	CCT	LM	ANG.	OSCILANTE CUT (mm)	P.V.P
TRIAC							
040698-T	8W	FW	2700K	450	36	NO Ø45	70,82 €
040704-T	8W	FW	3000K	450	36	NO Ø45	70,82 €
040711-T	8W	FW	4000K	450	36	NO Ø45	70,82 €
040728-T	8W	FBK	2700K	450	36	NO Ø45	70,82 €
040735-T	8W	FBK	3000K	450	36	NO Ø45	70,82 €
040742-T	8W	FBK	4000K	450	36	NO Ø45	70,82 €
0-10V							
040698-0	8W	FW	2700K	450	36	NO Ø45	70,82 €
040704-0	8W	FW	3000K	450	36	NO Ø45	70,82 €
040711-0	8W	FW	4000K	450	36	NO Ø45	70,82 €
040728-0	8W	FBK	2700K	450	36	NO Ø45	70,82 €
040735-0	8W	FBK	3000K	450	36	NO Ø45	70,82 €
040742-0	8W	FBK	4000K	450	36	NO Ø45	70,82 €
DALI/PUSH							
040698-D	8W	FW	2700K	450	36	NO Ø45	70,82 €
040704-D	8W	FW	3000K	450	36	NO Ø45	70,82 €
040711-D	8W	FW	4000K	450	36	NO Ø45	70,82 €
040728-D	8W	FBK	2700K	450	36	NO Ø45	70,82 €
040735-D	8W	FBK	3000K	450	36	NO Ø45	70,82 €
040742-D	8W	FBK	4000K	450	36	NO Ø45	70,82 €

ACCESORIOS/ACCESSORIES

REF.	DESCRIPCIÓN	P.V.P.
020768	C45-TRIMLESS	1,20 €

ÓPTICAS/OPTICS

REF.	DESCRIPCIÓN	P.V.P.
021000	LENS 24°	1,20 €

SERIES MINIMALIST - TRIMLESS - LC3298 - 12W

REF.	POW.	ACABADO	CCT	LM	ANG.	OSCILANTE CUT (mm)	P.V.P
040759	12W	FW	2700K	700	36	NO Ø55	38,33 €
040766	12W	FW	3000K	700	36	NO Ø55	38,33 €
040773	12W	FW	4000K	700	36	NO Ø55	38,33 €
040780	12W	FBK	2700K	700	36	NO Ø55	38,33 €
040797	12W	FBK	3000K	700	36	NO Ø55	38,33 €
040803	12W	FBK	4000K	700	36	NO Ø55	38,33 €

REGULACIONES/DIMMING

REF.	POW.	ACABADO	CCT	LM	ANG.	OSCILANTE CUT (mm)	P.V.P.
TRIAC							
040759-T	12W	FW	2700K	700	36	NO Ø55	73,33 €
040766-T	12W	FW	3000K	700	36	NO Ø55	73,33 €
040773-T	12W	FW	4000K	700	36	NO Ø55	73,33 €
040780-T	12W	FBK	2700K	700	36	NO Ø55	73,33 €
040797-T	12W	FBK	3000K	700	36	NO Ø55	73,33 €
040803-T	12W	FBK	4000K	700	36	NO Ø55	73,33 €
0-10V							
040759-0	12W	FW	2700K	700	36	NO Ø55	73,33 €
040766-0	12W	FW	3000K	700	36	NO Ø55	73,33 €
040773-0	12W	FW	4000K	700	36	NO Ø55	73,33 €
040780-0	12W	FBK	2700K	700	36	NO Ø55	73,33 €
040797-0	12W	FBK	3000K	700	36	NO Ø55	73,33 €
040803-0	12W	FBK	4000K	700	36	NO Ø55	73,33 €
DALI/PUSH							
040759-D	12W	FW	2700K	700	36	NO Ø55	73,33 €
040766-D	12W	FW	3000K	700	36	NO Ø55	73,33 €
040773-D	12W	FW	4000K	700	36	NO Ø55	73,33 €
040780-D	12W	FBK	2700K	700	36	NO Ø55	73,33 €
040797-D	12W	FBK	3000K	700	36	NO Ø55	73,33 €
040803-D	12W	FBK	4000K	700	36	NO Ø55	73,33 €

ACCESORIOS/ACCESSORIES

REF.	DESCRIPCIÓN	P.V.P.
021017	C55-TRIMLESS	1,50 €

ÓPTICAS/OPTICS

REF.	DESCRIPCIÓN	P.V.P.
021024	LENS 24°	1,50 €

SERIES ULTRA - NARROW BEAM



 **PRECISION LIGHT**
ÁNGULO DE APERTURA 6° BEAM ANGLE 6°

Al 8W 12W 480 LUMEN 720 LUMEN 2.700°K 3.000°K 4.000°K  6°  24°  36°  Ø55mm  Ø75mm **AC** 200V 240V **Hz** 50/60

IP 20 RATED  NO FLICKERING **CRI** >95 **PF** >0.9 **RoHS** COMPLIANT **CE** **5 AÑOS** GARANTÍA

DIMENSIONES DIMENSIONS

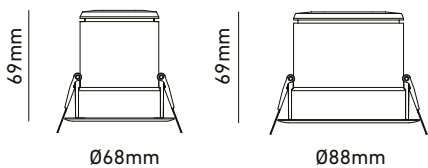

ACABADOS FINISHES



FOTOMETRÍA PHOTOMETRY

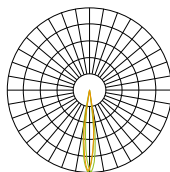

REGULACIÓN DIMMING

TRIAC - 0-10V - DALI

* CASAMBI A CONSULTAR

SERIES ULTRA - NARROW BEAM - LC3316 - 8W

REF.	POW.	ACABADO	CCT	LM	ANG.	OSCILANTE CUT (mm)	P.V.P
040810	8W	FW	2700K	480	6	NO Ø55	38,90 €
040827	8W	FW	3000K	480	6	NO Ø55	38,90 €
040834	8W	FW	4000K	480	6	NO Ø55	38,90 €
040841	8W	FBK	2700K	480	6	NO Ø55	38,90 €
040858	8W	FBK	3000K	480	6	NO Ø55	38,90 €
040865	8W	FBK	4000K	480	6	NO Ø55	38,90 €

REGULACIONES/DIMMING

REF.	POW.	ACABADO	CCT	LM	ANG.	OSCILANTE CUT (mm)	P.V.P
TRIAC							
040810-T	8W	FW	2700K	480	6	NO Ø55	73,90 €
040827-T	8W	FW	3000K	480	6	NO Ø55	73,90 €
040834-T	8W	FW	4000K	480	6	NO Ø55	73,90 €
040841-T	8W	FBK	2700K	480	6	NO Ø55	73,90 €
040858-T	8W	FBK	3000K	480	6	NO Ø55	73,90 €
040865-T	8W	FBK	4000K	480	6	NO Ø55	73,90 €
0-10V							
040810-0	8W	FW	2700K	480	6	NO Ø55	73,90 €
040827-0	8W	FW	3000K	480	6	NO Ø55	73,90 €
040834-0	8W	FW	4000K	480	6	NO Ø55	73,90 €
040841-0	8W	FBK	2700K	480	6	NO Ø55	73,90 €
040858-0	8W	FBK	3000K	480	6	NO Ø55	73,90 €
040865-0	8W	FBK	4000K	480	6	NO Ø55	73,90 €
DALI/PUSH							
040810-D	8W	FW	2700K	480	6	NO Ø55	73,90 €
040827-D	8W	FW	3000K	480	6	NO Ø55	73,90 €
040834-D	8W	FW	4000K	480	6	NO Ø55	73,90 €
040841-D	8W	FBK	2700K	480	6	NO Ø55	73,90 €
040858-D	8W	FBK	3000K	480	6	NO Ø55	73,90 €
040865-D	8W	FBK	4000K	480	6	NO Ø55	73,90 €

ACCESORIOS/ACCESSORIES

REF.	DESCRIPCIÓN	P.V.P.
021048	C55 FW	1,50 €
021062	C55 FBK	1,50 €
021079	C55 ANTIQUE BRONZE	1,50 €
021246	C55 GOLD	1,50 €

ÓPTICAS/OPTICS

REF.	DESCRIPCIÓN	P.V.P.
021253	LENS 24°	1,20 €
021260	LENS 36°	1,20 €

SERIES ULTRA - NARROW BEAM - LC3316 - 12W

REF.	POW.	ACABADO	CCT	LM	ANG.	OSCILANTE CUT (mm)	P.V.P
040872	12W	FW	2700K	720	6	NO Ø75	42,90 €
040889	12W	FW	3000K	720	6	NO Ø75	42,90 €
040896	12W	FW	4000K	720	6	NO Ø75	42,90 €
040902	12W	FBK	2700K	720	6	NO Ø75	42,90 €
040919	12W	FBK	3000K	720	6	NO Ø75	42,90 €
040926	12W	FBK	4000K	720	6	NO Ø75	42,90 €

REGULACIONES/DIMMING

REF.	POW.	ACABADO	CCT	LM	ANG.	OSCILANTE CUT (mm)	P.V.P
TRIAC							
040872-T	12W	FW	2700K	720	6	NO Ø75	77,90 €
040889-T	12W	FW	3000K	720	6	NO Ø75	77,90 €
040896-T	12W	FW	4000K	720	6	NO Ø75	77,90 €
040902-T	12W	FBK	2700K	720	6	NO Ø75	77,90 €
040919-T	12W	FBK	3000K	720	6	NO Ø75	77,90 €
040926-T	12W	FBK	4000K	720	6	NO Ø75	77,90 €
0-10V							
040872-0	12W	FW	2700K	720	6	NO Ø75	77,90 €
040889-0	12W	FW	3000K	720	6	NO Ø75	77,90 €
040896-0	12W	FW	4000K	720	6	NO Ø75	77,90 €
040902-0	12W	FBK	2700K	720	6	NO Ø75	77,90 €
040919-0	12W	FBK	3000K	720	6	NO Ø75	77,90 €
040926-0	12W	FBK	4000K	720	6	NO Ø75	77,90 €
DALI/PUSH							
040872-D	12W	FW	2700K	720	6	NO Ø75	77,90 €
040889-D	12W	FW	3000K	720	6	NO Ø75	77,90 €
040896-D	12W	FW	4000K	720	6	NO Ø75	77,90 €
040902-D	12W	FBK	2700K	720	6	NO Ø75	77,90 €
040919-D	12W	FBK	3000K	720	6	NO Ø75	77,90 €
040926-D	12W	FBK	4000K	720	6	NO Ø75	77,90 €

ACCESORIOS/ACCESSORIES

REF.	DESCRIPCIÓN	P.V.P.
021496	C75 FW	2,00 €
021502	C75 FBK	2,00 €
021519	C75 ANTIQUE BRONZE	2,00 €
021567	C75 GOLD	2,00 €

ÓPTICAS/OPTICS

REF.	DESCRIPCIÓN	P.V.P.
021703	LENS 24°	2,00 €
021710	LENS 36°	2,00 €

SERIES FOCUS ZOOM



AI **3W** **6W** **12W** **180 LUMEN** **480 LUMEN** **960 LUMEN** **2.700°K** **3.000°K** **4.000°K** **15°-60°** **360°** **Ø35mm** **Ø55mm** **Ø75mm**
AC 200V 240V **CRI >95** **PF >0.9** **Hz 50/60** **IP 20 RATED** **NO FLICKERING** **RoHS COMPLIANT** **CE** **5 AÑOS GARANTÍA**

DIMENSIONES DIMENSIONS

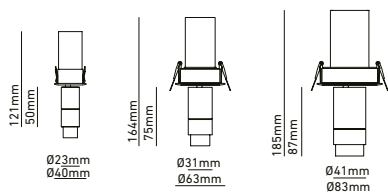

ACABADOS FINISHES



FOTOMETRÍA PHOTOMETRY

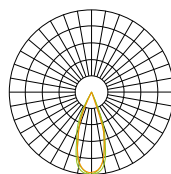

REGULACIÓN DIMMING

TRIAC - 0-10V - DALI

* CASAMBI A CONSULTAR

SERIES FOCUS ZOOM - LC3306 - 3W

REF.	POW.	ACABADO	CCT	LM	ANG.	OSCILANTE CUT (mm)	P.V.P
040933	3W	FW	2700K	180	15° - 60°	SI Ø35	40,90 €
040940	3W	FW	3000K	180	15° - 60°	SI Ø35	40,90 €
040957	3W	FW	4000K	180	15° - 60°	SI Ø35	40,90 €
040964	3W	FBK	2700K	180	15° - 60°	SI Ø35	40,90 €
040971	3W	FBK	3000K	180	15° - 60°	SI Ø35	40,90 €
040988	3W	FBK	4000K	180	15° - 60°	SI Ø35	40,90 €

REGULACIONES/DIMMING

REF.	POW.	ACABADO	CCT	LM	ANG.	OSCILANTE CUT (mm)	P.V.P
TRIAC							
040933-T	3W	FW	2700K	180	15° - 60°	SI Ø35	75,90 €
040940-T	3W	FW	3000K	180	15° - 60°	SI Ø35	75,90 €
040957-T	3W	FW	4000K	180	15° - 60°	SI Ø35	75,90 €
040964-T	3W	FBK	2700K	180	15° - 60°	SI Ø35	75,90 €
040971-T	3W	FBK	3000K	180	15° - 60°	SI Ø35	75,90 €
040988-T	3W	FBK	4000K	180	15° - 60°	SI Ø35	75,90 €
0-10V							
040933-0	3W	FW	2700K	180	15° - 60°	SI Ø35	75,90 €
040940-0	3W	FW	3000K	180	15° - 60°	SI Ø35	75,90 €
040957-0	3W	FW	4000K	180	15° - 60°	SI Ø35	75,90 €
040964-0	3W	FBK	2700K	180	15° - 60°	SI Ø35	75,90 €
040971-0	3W	FBK	3000K	180	15° - 60°	SI Ø35	75,90 €
040988-0	3W	FBK	4000K	180	15° - 60°	SI Ø35	75,90 €
DALI/PUSH							
040933-D	3W	FW	2700K	180	15° - 60°	SI Ø35	75,90 €
040940-D	3W	FW	3000K	180	15° - 60°	SI Ø35	75,90 €
040957-D	3W	FW	4000K	180	15° - 60°	SI Ø35	75,90 €
040964-D	3W	FBK	2700K	180	15° - 60°	SI Ø35	75,90 €
040971-D	3W	FBK	3000K	180	15° - 60°	SI Ø35	75,90 €
040988-D	3W	FBK	4000K	180	15° - 60°	SI Ø35	75,90 €

ACCESORIOS/ACCESSORIES

REF.	DESCRIPCIÓN	P.V.P.
------	-------------	--------

SERIES FOCUS ZOOM - LC3306 - 6W

REF.	POW.	ACABADO	CCT	LM	ANG.	OSCILANTE CUT (mm)	P.V.P
040995	6W	FW	2700K	480	15° - 60°	SI Ø55	45,53 €
041008	6W	FW	3000K	480	15° - 60°	SI Ø55	45,53 €
041015	6W	FW	4000K	480	15° - 60°	SI Ø55	45,53 €
041022	6W	FBK	2700K	480	15° - 60°	SI Ø55	45,53 €
041039	6W	FBK	3000K	480	15° - 60°	SI Ø55	45,53 €
041046	6W	FBK	4000K	480	15° - 60°	SI Ø55	45,53 €

REGULACIONES/DIMMING

REF.	POW.	ACABADO	CCT	LM	ANG.	OSCILANTE CUT (mm)	P.V.P
TRIAC							
040995-T	6W	FW	2700K	480	15° - 60°	SI Ø55	81,53 €
041008-T	6W	FW	3000K	480	15° - 60°	SI Ø55	81,53 €
041015-T	6W	FW	4000K	480	15° - 60°	SI Ø55	81,53 €
041022-T	6W	FBK	2700K	480	15° - 60°	SI Ø55	81,53 €
041039-T	6W	FBK	3000K	480	15° - 60°	SI Ø55	81,53 €
041046-T	6W	FBK	4000K	480	15° - 60°	SI Ø55	81,53 €
0-10V							
040995-0	6W	FW	2700K	480	15° - 60°	SI Ø55	81,53 €
041008-0	6W	FW	3000K	480	15° - 60°	SI Ø55	81,53 €
041015-0	6W	FW	4000K	480	15° - 60°	SI Ø55	81,53 €
041022-0	6W	FBK	2700K	480	15° - 60°	SI Ø55	81,53 €
041039-0	6W	FBK	3000K	480	15° - 60°	SI Ø55	81,53 €
041046-0	6W	FBK	4000K	480	15° - 60°	SI Ø55	81,53 €
DALI/PUSH							
040995-D	6W	FW	2700K	480	15° - 60°	SI Ø55	81,53 €
041008-D	6W	FW	3000K	480	15° - 60°	SI Ø55	81,53 €
041015-D	6W	FW	4000K	480	15° - 60°	SI Ø55	81,53 €
041022-D	6W	FBK	2700K	480	15° - 60°	SI Ø55	81,53 €
041039-D	6W	FBK	3000K	480	15° - 60°	SI Ø55	81,53 €
041046-D	6W	FBK	4000K	480	15° - 60°	SI Ø55	81,53 €

ACCESORIOS/ACCESSORIES

REF.	DESCRIPCIÓN	P.V.P.
021963	C55-TRIMLESS	1,50 €

SERIES FOCUS ZOOM - LC3306 - 12W

REF.	POW.	ACABADO	CCT	LM	ANG.	OSCILANTE CUT (mm)	P.V.P
041176	12W	FW	2700K	960	15° - 60°	SI Ø75	54,96 €
041183	12W	FW	3000K	960	15° - 60°	SI Ø75	54,96 €
041190	12W	FW	4000K	960	15° - 60°	SI Ø75	54,96 €
041206	12W	FBK	2700K	960	15° - 60°	SI Ø75	54,96 €
041213	12W	FBK	3000K	960	15° - 60°	SI Ø75	54,96 €
041220	12W	FBK	4000K	960	15° - 60°	SI Ø75	54,96 €

REGULACIONES/DIMMING

REF.	POW.	ACABADO	CCT	LM	ANG.	OSCILANTE CUT (mm)	P.V.P.
TRIAC							
041176-T	12W	FW	2700K	960	15° - 60°	SI Ø75	89,86 €
041183-T	12W	FW	3000K	960	15° - 60°	SI Ø75	89,86 €
041190-T	12W	FW	4000K	960	15° - 60°	SI Ø75	89,86 €
041206-T	12W	FBK	2700K	960	15° - 60°	SI Ø75	89,86 €
041213-T	12W	FBK	3000K	960	15° - 60°	SI Ø75	89,86 €
041220-T	12W	FBK	4000K	960	15° - 60°	SI Ø75	89,86 €
0-10V							
041176-0	12W	FW	2700K	960	15° - 60°	SI Ø75	89,86 €
041183-0	12W	FW	3000K	960	15° - 60°	SI Ø75	89,86 €
041190-0	12W	FW	4000K	960	15° - 60°	SI Ø75	89,86 €
041206-0	12W	FBK	2700K	960	15° - 60°	SI Ø75	89,86 €
041213-0	12W	FBK	3000K	960	15° - 60°	SI Ø75	89,86 €
041220-0	12W	FBK	4000K	960	15° - 60°	SI Ø75	89,86 €
DALI/PUSH							
041176-D	12W	FW	2700K	960	15° - 60°	SI Ø75	89,86 €
041183-D	12W	FW	3000K	960	15° - 60°	SI Ø75	89,86 €
041190-D	12W	FW	4000K	960	15° - 60°	SI Ø75	89,86 €
041206-D	12W	FBK	2700K	960	15° - 60°	SI Ø75	89,86 €
041213-D	12W	FBK	3000K	960	15° - 60°	SI Ø75	89,86 €
041220-D	12W	FBK	4000K	960	15° - 60°	SI Ø75	89,86 €

ACCESORIOS/ACCESSORIES

REF.	DESCRIPCIÓN	P.V.P.
022359	C75-TRIMLESS	2,00 €

SERIES ORBITA UGR



8W

15W

20W

28W

480
LUMEN

900
LUMEN

1200
LUMEN

1680
LUMEN

2.700°K

3.000°K

4.000°K

48°

AC
100V
240V



Ø75mm



Ø120mm



Ø165mm



Ø205mm

Hz
50/60

CRI
>95

PF
>0.9

IP 20
RATED

RoHS
COMPLIANT



5 AÑOS
GARANTÍA

DIMENSIONES DIMENSIONS

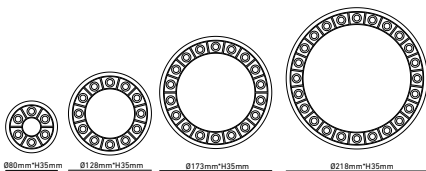

FOTOMETRÍA PHOTOMETRY

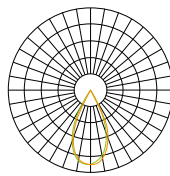

ACABADOS FINISHES



REGULACIÓN DIMMING

TRIAC - 0-10V - DALI

* CASAMBI A CONSULTAR

SERIES ORBITA UGR - KED279 - 8W

REF.	POW.	ACABADO	CCT	LM	ANG.	OSCILANTE CUT (mm)	P.V.P
041053	8W	FW	2700K	680	48	NO Ø75	23,08 €
041060	8W	FW	3000K	680	48	NO Ø75	23,08 €
041077	8W	FW	4000K	680	48	NO Ø75	23,08 €
041084	8W	FBK	2700K	680	48	NO Ø75	23,08 €
041091	8W	FBK	3000K	680	48	NO Ø75	23,08 €
041107	8W	FBK	4000K	680	48	NO Ø75	23,08 €

REGULACIONES/DIMMING

REF.	POW.	ACABADO	CCT	LM	ANG.	OSCILANTE CUT (mm)	P.V.P
TRIAC							
041053-T	8W	FW	2700K	680	48	NO Ø75	58,08 €
041060-T	8W	FW	3000K	680	48	NO Ø75	58,08 €
041077-T	8W	FW	4000K	680	48	NO Ø75	58,08 €
041084-T	8W	FBK	2700K	680	48	NO Ø75	58,08 €
041091-T	8W	FBK	3000K	680	48	NO Ø75	58,08 €
041107-T	8W	FBK	4000K	680	48	NO Ø75	58,08 €
0-10V							
041053-0	8W	FW	2700K	680	48	NO Ø75	58,08 €
041060-0	8W	FW	3000K	680	48	NO Ø75	58,08 €
041077-0	8W	FW	4000K	680	48	NO Ø75	58,08 €
041084-0	8W	FBK	2700K	680	48	NO Ø75	58,08 €
041091-0	8W	FBK	3000K	680	48	NO Ø75	58,08 €
041107-0	8W	FBK	4000K	680	48	NO Ø75	58,08 €
DALI/PUSH							
041053-D	8W	FW	2700K	680	48	NO Ø75	58,08 €
041060-D	8W	FW	3000K	680	48	NO Ø75	58,08 €
041077-D	8W	FW	4000K	680	48	NO Ø75	58,08 €
041084-D	8W	FBK	2700K	680	48	NO Ø75	58,08 €
041091-D	8W	FBK	3000K	680	48	NO Ø75	58,08 €
041107-D	8W	FBK	4000K	680	48	NO Ø75	58,08 €

SERIES ORBITA UGR - KED279 - 15W

REF.	POW.	ACABADO	CCT	LM	ANG.	OSCILANTE CUT (mm)	P.V.P
041114	15W	FW	2700K	1200	48	NO Ø120	35,39 €
041121	15W	FW	3000K	1200	48	NO Ø120	35,39 €
041138	15W	FW	4000K	1200	48	NO Ø120	35,39 €
041145	15W	FBK	2700K	1200	48	NO Ø120	35,39 €
041152	15W	FBK	3000K	1200	48	NO Ø120	35,39 €
041169	15W	FBK	4000K	1200	48	NO Ø120	35,39 €

REGULACIONES/DIMMING

REF.	POW.	ACABADO	CCT	LM	ANG.	OSCILANTE CUT (mm)	P.V.P
TRIAC							
041114-T	15W	FW	2700K	1200	48	NO Ø120	70,39 €
041121-T	15W	FW	3000K	1200	48	NO Ø120	70,39 €
041138-T	15W	FW	4000K	1200	48	NO Ø120	70,39 €
041145-T	15W	FBK	2700K	1200	48	NO Ø120	70,39 €
041152-T	15W	FBK	3000K	1200	48	NO Ø120	70,39 €
041169-T	15W	FBK	4000K	1200	48	NO Ø120	70,39 €
0-10V							
041114-0	15W	FW	2700K	1200	48	NO Ø120	70,39 €
041121-0	15W	FW	3000K	1200	48	NO Ø120	70,39 €
041138-0	15W	FW	4000K	1200	48	NO Ø120	70,39 €
041145-0	15W	FBK	2700K	1200	48	NO Ø120	70,39 €
041152-0	15W	FBK	3000K	1200	48	NO Ø120	70,39 €
041169-0	15W	FBK	4000K	1200	48	NO Ø120	70,39 €
DALI/PUSH							
041114-D	15W	FW	2700K	1200	48	NO Ø120	70,39 €
041121-D	15W	FW	3000K	1200	48	NO Ø120	70,39 €
041138-D	15W	FW	4000K	1200	48	NO Ø120	70,39 €
041145-D	15W	FBK	2700K	1200	48	NO Ø120	70,39 €
041152-D	15W	FBK	3000K	1200	48	NO Ø120	70,39 €
041169-D	15W	FBK	4000K	1200	48	NO Ø120	70,39 €

SERIES ORBITA UGR - KED279 - 20W

REF.	POW.	ACABADO	CCT	LM	ANG.	OSCILANTE CUT (mm)	P.V.P
041237	20W	FW	2700K	1600	48	NO Ø165	49,65 €
041244	20W	FW	3000K	1600	48	NO Ø165	49,65 €
041251	20W	FW	4000K	1600	48	NO Ø165	49,65 €
041268	20W	FBK	2700K	1600	48	NO Ø165	49,65 €
041275	20W	FBK	3000K	1600	48	NO Ø165	49,65 €
041282	20W	FBK	4000K	1600	48	NO Ø165	49,65 €

REGULACIONES/DIMMING

REF.	POW.	ACABADO	CCT	LM	ANG.	OSCILANTE CUT (mm)	P.V.P
TRIAC							
041237-T	20W	FW	2700K	1600	48	NO Ø165	84,65 €
041244-T	20W	FW	3000K	1600	48	NO Ø165	84,65 €
041251-T	20W	FW	4000K	1600	48	NO Ø165	84,65 €
041268-T	20W	FBK	2700K	1600	48	NO Ø165	84,65 €
041275-T	20W	FBK	3000K	1600	48	NO Ø165	84,65 €
041282-T	20W	FBK	4000K	1600	48	NO Ø165	84,65 €
0-10V							
041237-0	20W	FW	2700K	1600	48	NO Ø165	84,65 €
041244-0	20W	FW	3000K	1600	48	NO Ø165	84,65 €
041251-0	20W	FW	4000K	1600	48	NO Ø165	84,65 €
041268-0	20W	FBK	2700K	1600	48	NO Ø165	84,65 €
041275-0	20W	FBK	3000K	1600	48	NO Ø165	84,65 €
041282-0	20W	FBK	4000K	1600	48	NO Ø165	84,65 €
DALI/PUSH							
041237-D	20W	FW	2700K	1600	48	NO Ø165	84,65 €
041244-D	20W	FW	3000K	1600	48	NO Ø165	84,65 €
041251-D	20W	FW	4000K	1600	48	NO Ø165	84,65 €
041268-D	20W	FBK	2700K	1600	48	NO Ø165	84,65 €
041275-D	20W	FBK	3000K	1600	48	NO Ø165	84,65 €
041282-D	20W	FBK	4000K	1600	48	NO Ø165	84,65 €

SERIES ORBITA UGR - KED279 - 28W

REF.	POW.	ACABADO	CCT	LM	ANG.	OSCILANTE CUT (mm)	P.V.P
041299	28W	FW	2700K	2240	48	NO Ø205	63,95 €
041305	28W	FW	3000K	2240	48	NO Ø205	63,95 €
041312	28W	FW	4000K	2240	48	NO Ø205	63,95 €
041329	28W	FBK	2700K	2240	48	NO Ø205	63,95 €
041336	28W	FBK	3000K	2240	48	NO Ø205	63,95 €
041343	28W	FBK	4000K	2240	48	NO Ø205	63,95 €

REGULACIONES/DIMMING

REF.	POW.	ACABADO	CCT	LM	ANG.	OSCILANTE CUT (mm)	P.V.P
TRIAC							
041299-T	28W	FW	2700K	2240	48	NO Ø205	98,95 €
041305-T	28W	FW	3000K	2240	48	NO Ø205	98,95 €
041312-T	28W	FW	4000K	2240	48	NO Ø205	98,95 €
041329-T	28W	FBK	2700K	2240	48	NO Ø205	98,95 €
041336-T	28W	FBK	3000K	2240	48	NO Ø205	98,95 €
041343-T	28W	FBK	4000K	2240	48	NO Ø205	98,95 €
0-10V							
041299-0	28W	FW	2700K	2240	48	NO Ø205	98,95 €
041305-0	28W	FW	3000K	2240	48	NO Ø205	98,95 €
041312-0	28W	FW	4000K	2240	48	NO Ø205	98,95 €
041329-0	28W	FBK	2700K	2240	48	NO Ø205	98,95 €
041336-0	28W	FBK	3000K	2240	48	NO Ø205	98,95 €
041343-0	28W	FBK	4000K	2240	48	NO Ø205	98,95 €
DALI/PUSH							
041299-D	28W	FW	2700K	2240	48	NO Ø205	98,95 €
041305-D	28W	FW	3000K	2240	48	NO Ø205	98,95 €
041312-D	28W	FW	4000K	2240	48	NO Ø205	98,95 €
041329-D	28W	FBK	2700K	2240	48	NO Ø205	98,95 €
041336-D	28W	FBK	3000K	2240	48	NO Ø205	98,95 €
041343-D	28W	FBK	4000K	2240	48	NO Ø205	98,95 €

SERIES INTEGRA EMPOTRABLE



AI **5W** **10W** **20W** **400 LUMEN** **800 LUMEN** **1600 LUMEN** **2.700°K** **3.000°K** **4.000°K** **AC 100V 240V**

Hz 50/60 **CRI >95** **PF >0.9** **UGR <17** **IP20 RATED** **RoHS COMPLIANT** **CE** **5 AÑOS GARANTÍA**

DIMENSIONES DIMENSIONS

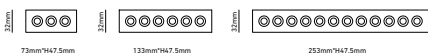

FOTOMETRÍA PHOTOMETRY

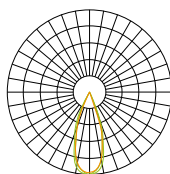

ACABADOS FINISHES



REGULACIÓN DIMMING

TRIAC - 0-10V - DALI

* CASAMBI A CONSULTAR

SERIES INTEGRAL EMPOTRABLE - KED776 - 5W

REF.	POW.	ACABADO	CCT	LM	ANG.	OSCILANTE CUT (mm)	P.V.P.
041350	5W	FW	2700K	400	36	NO 68*25	24,45 €
041367	5W	FW	3000K	400	36	NO 68*25	24,45 €
041374	5W	FW	4000K	400	36	NO 68*25	24,45 €
041381	5W	FBK	2700K	400	36	NO 68*25	24,45 €
041398	5W	FBK	3000K	400	36	NO 68*25	24,45 €
041404	5W	FBK	4000K	400	36	NO 68*25	24,45 €

REGULACIONES/DIMMING

REF.	POW.	ACABADO	CCT	LM	ANG.	OSCILANTE CUT (mm)	P.V.P.
TRIAC							
041350-T	5W	FW	2700K	400	36	NO 68*25	59,45 €
041367-T	5W	FW	3000K	400	36	NO 68*25	59,45 €
041374-T	5W	FW	4000K	400	36	NO 68*25	59,45 €
041381-T	5W	FBK	2700K	400	36	NO 68*25	59,45 €
041398-T	5W	FBK	3000K	400	36	NO 68*25	59,45 €
041404-T	5W	FBK	4000K	400	36	NO 68*25	59,45 €
0-10V							
041350-0	5W	FW	2700K	400	36	NO 68*25	59,45 €
041367-0	5W	FW	3000K	400	36	NO 68*25	59,45 €
041374-0	5W	FW	4000K	400	36	NO 68*25	59,45 €
041381-0	5W	FBK	2700K	400	36	NO 68*25	59,45 €
041398-0	5W	FBK	3000K	400	36	NO 68*25	59,45 €
041404-0	5W	FBK	4000K	400	36	NO 68*25	59,45 €
DALI/PUSH							
041350-D	5W	FW	2700K	400	36	NO 68*25	59,45 €
041367-D	5W	FW	3000K	400	36	NO 68*25	59,45 €
041374-D	5W	FW	4000K	400	36	NO 68*25	59,45 €
041381-D	5W	FBK	2700K	400	36	NO 68*25	59,45 €
041398-D	5W	FBK	3000K	400	36	NO 68*25	59,45 €
041404-D	5W	FBK	4000K	400	36	NO 68*25	59,45 €

ACCESORIOS/ACCESSORIES

REF.	DESCRIPCIÓN	P.V.P.
------	-------------	--------

ÓPTICAS/OPTICS

REF.	DESCRIPCIÓN	P.V.P.
022731	5W-LENS 15°	3,00 €
022748	5W-LENS 45°	3,00 €

SERIES INTEGRA EMPOTRABLE - KED776 - 10W

REF.	POW.	ACABADO	CCT	LM	ANG.	OSCILANTE CUT (mm)	P.V.P
041411	10W	FW	2700K	800	36	NO 128*25	29,74 €
041428	10W	FW	3000K	800	36	NO 128*25	29,74 €
041435	10W	FW	4000K	800	36	NO 128*25	29,74 €
041442	10W	FBK	2700K	800	36	NO 128*25	29,74 €
041459	10W	FBK	3000K	800	36	NO 128*25	29,74 €
041466	10W	FBK	4000K	800	36	NO 128*25	29,74 €

REGULACIONES/DIMMING

REF.	POW.	ACABADO	CCT	LM	ANG.	OSCILANTE CUT (mm)	P.V.P
TRIAC							
041411-T	10W	FW	2700K	800	36	NO 128*25	64,74 €
041428-T	10W	FW	3000K	800	36	NO 128*25	64,74 €
041435-T	10W	FW	4000K	800	36	NO 128*25	64,74 €
041442-T	10W	FBK	2700K	800	36	NO 128*25	64,74 €
041459-T	10W	FBK	3000K	800	36	NO 128*25	64,74 €
041466-T	10W	FBK	4000K	800	36	NO 128*25	64,74 €
0-10V							
041411-0	10W	FW	2700K	800	36	NO 128*25	64,74 €
041428-0	10W	FW	3000K	800	36	NO 128*25	64,74 €
041435-0	10W	FW	4000K	800	36	NO 128*25	64,74 €
041442-0	10W	FBK	2700K	800	36	NO 128*25	64,74 €
041459-0	10W	FBK	3000K	800	36	NO 128*25	64,74 €
041466-0	10W	FBK	4000K	800	36	NO 128*25	64,74 €
DALI/PUSH							
041411-D	10W	FW	2700K	800	36	NO 128*25	64,74 €
041428-D	10W	FW	3000K	800	36	NO 128*25	64,74 €
041435-D	10W	FW	4000K	800	36	NO 128*25	64,74 €
041442-D	10W	FBK	2700K	800	36	NO 128*25	64,74 €
041459-D	10W	FBK	3000K	800	36	NO 128*25	64,74 €
041466-D	10W	FBK	4000K	800	36	NO 128*25	64,74 €

ACCESORIOS/ACCESSORIES

REF.	DESCRIPCIÓN	P.V.P.
------	-------------	--------

ÓPTICAS/OPTICS

REF.	DESCRIPCIÓN	P.V.P.
022755	10W-LENS 15°	6,00 €
022762	10W-LENS 45°	6,00 €

SERIES INTEGRAL EMPOTRABLE - KED776 - 20W

REF.	POW.	ACABADO	CCT	LM	ANG.	OSCILANTE CUT (mm)	P.V.P
041473	20W	FW	2700K	1600	36	NO 248*25	48,30 €
041480	20W	FW	3000K	1600	36	NO 248*25	48,30 €
041497	20W	FW	4000K	1600	36	NO 248*25	48,30 €
041503	20W	FBK	2700K	1600	36	NO 248*25	48,30 €
041510	20W	FBK	3000K	1600	36	NO 248*25	48,30 €
041527	20W	FBK	4000K	1600	36	NO 248*25	48,30 €

REGULACIONES/DIMMING

REF.	POW.	ACABADO	CCT	LM	ANG.	OSCILANTE CUT (mm)	P.V.P
TRIAC							
041473-T	20W	FW	2700K	1600	36	NO 248*25	83,30 €
041480-T	20W	FW	3000K	1600	36	NO 248*25	83,30 €
041497-T	20W	FW	4000K	1600	36	NO 248*25	83,30 €
041503-T	20W	FBK	2700K	1600	36	NO 248*25	83,30 €
041510-T	20W	FBK	3000K	1600	36	NO 248*25	83,30 €
041527-T	20W	FBK	4000K	1600	36	NO 248*25	83,30 €
0-10V							
041473-0	20W	FW	2700K	1600	36	NO 248*25	83,30 €
041480-0	20W	FW	3000K	1600	36	NO 248*25	83,30 €
041497-0	20W	FW	4000K	1600	36	NO 248*25	83,30 €
041503-0	20W	FBK	2700K	1600	36	NO 248*25	83,30 €
041510-0	20W	FBK	3000K	1600	36	NO 248*25	83,30 €
041527-0	20W	FBK	4000K	1600	36	NO 248*25	83,30 €
DALI/PUSH							
041473-D	20W	FW	2700K	1600	36	NO 248*25	83,30 €
041480-D	20W	FW	3000K	1600	36	NO 248*25	83,30 €
041497-D	20W	FW	4000K	1600	36	NO 248*25	83,30 €
041503-D	20W	FBK	2700K	1600	36	NO 248*25	83,30 €
041510-D	20W	FBK	3000K	1600	36	NO 248*25	83,30 €
041527-D	20W	FBK	4000K	1600	36	NO 248*25	83,30 €

ACCESORIOS/ACCESSORIES

REF.	DESCRIPCIÓN	P.V.P.
------	-------------	--------

ÓPTICAS/OPTICS

REF.	DESCRIPCIÓN	P.V.P.
022779	20W-LENS 15°	10,00 €
022786	20W-LENS 45°	10,00 €

SERIES INTEGRA ORIENTABLE



Al **5W** **10W** **20W** **400 LUMEN** **800 LUMEN** **1600 LUMEN** **2.700°K** **3.000°K** **4.000°K** **15°** **36°** **45°** **AC 100V 240V**

Hz 50/60 **CRI >95** **PF >0.9** **UGR <17** **NO FLICKERING** **IP20 RATED** **RoHS COMPLIANT** **CE** **5 AÑOS GARANTÍA**

DIMENSIONES DIMENSIONS

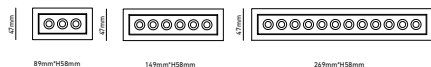

FOTOMETRÍA PHOTOMETRY

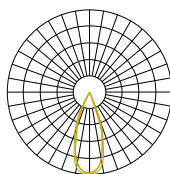

ACABADOS FINISHES



REGULACIÓN DIMMING

TRIAC - 0-10V - DALI

* CASAMBI A CONSULTAR

ACCESORIOS ACCESSORIES

SERIES INTEGRA ORIENTABLE - KED776 - 5W

REF.	POW.	ACABADO	CCT	LM	ANG.	OSCILANTE CUT (mm)	P.V.P
041534	5W	FW	2700K	400	36	SI 82*38	31,47 €
041541	5W	FW	3000K	400	36	SI 82*38	31,47 €
041558	5W	FW	4000K	400	36	SI 82*38	31,47 €
041565	5W	FBK	2700K	400	36	SI 82*38	31,47 €
041572	5W	FBK	3000K	400	36	SI 82*38	31,47 €
041589	5W	FBK	4000K	400	36	SI 82*38	31,47 €

REGULACIONES/DIMMING

REF.	POW.	ACABADO	CCT	LM	ANG.	OSCILANTE CUT (mm)	P.V.P.
TRIAC							
041534-T	5W	FW	2700K	400	36	SI 82*38	66,47 €
041541-T	5W	FW	3000K	400	36	SI 82*38	66,47 €
041558-T	5W	FW	4000K	400	36	SI 82*38	66,47 €
041565-T	5W	FBK	2700K	400	36	SI 82*38	66,47 €
041572-T	5W	FBK	3000K	400	36	SI 82*38	66,47 €
041589-T	5W	FBK	4000K	400	36	SI 82*38	66,47 €
0-10V							
041534-0	5W	FW	2700K	400	36	SI 82*38	66,47 €
041541-0	5W	FW	3000K	400	36	SI 82*38	66,47 €
041558-0	5W	FW	4000K	400	36	SI 82*38	66,47 €
041565-0	5W	FBK	2700K	400	36	SI 82*38	66,47 €
041572-0	5W	FBK	3000K	400	36	SI 82*38	66,47 €
041589-0	5W	FBK	4000K	400	36	SI 82*38	66,47 €
DALI/PUSH							
041534-D	5W	FW	2700K	400	36	SI 82*38	66,47 €
041541-D	5W	FW	3000K	400	36	SI 82*38	66,47 €
041558-D	5W	FW	4000K	400	36	SI 82*38	66,47 €
041565-D	5W	FBK	2700K	400	36	SI 82*38	66,47 €
041572-D	5W	FBK	3000K	400	36	SI 82*38	66,47 €
041589-D	5W	FBK	4000K	400	36	SI 82*38	66,47 €

ACCESORIOS/ACCESSORIES

REF.	DESCRIPCIÓN	P.V.P.
022793	5W-REFLECTOR FBK	3,00 €

ÓPTICAS/OPTICS

REF.	DESCRIPCIÓN	P.V.P.
022809	5W-LENS 15°	3,00 €
022809	5W-LENS 45°	3,00 €

SERIES INTEGRAL ORIENTABLE - KED776 - 10W

REF.	POW.	ACABADO	CCT	LM	ANG.	OSCILANTE CUT (mm)	P.V.P
041596	10W	FW	2700K	800	36	SI 144*38	37,78 €
041602	10W	FW	3000K	800	36	SI 144*38	37,78 €
041619	10W	FW	4000K	800	36	SI 144*38	37,78 €
041626	10W	FBK	2700K	800	36	SI 144*38	37,78 €
041633	10W	FBK	3000K	800	36	SI 144*38	37,78 €
041640	10W	FBK	4000K	800	36	SI 144*38	37,78 €

REGULACIONES/DIMMING

REF.	POW.	ACABADO	CCT	LM	ANG.	OSCILANTE CUT (mm)	P.V.P
TRIAC							
041596-T	10W	FW	2700K	800	36	SI 144*38	72,79 €
041602-T	10W	FW	3000K	800	36	SI 144*38	72,79 €
041619-T	10W	FW	4000K	800	36	SI 144*38	72,79 €
041626-T	10W	FBK	2700K	800	36	SI 144*38	72,79 €
041633-T	10W	FBK	3000K	800	36	SI 144*38	72,79 €
041640-T	10W	FBK	4000K	800	36	SI 144*38	72,79 €
0-10V							
041596-0	10W	FW	2700K	800	36	SI 144*38	72,79 €
041602-0	10W	FW	3000K	800	36	SI 144*38	72,79 €
041619-0	10W	FW	4000K	800	36	SI 144*38	72,79 €
041626-0	10W	FBK	2700K	800	36	SI 144*38	72,79 €
041633-0	10W	FBK	3000K	800	36	SI 144*38	72,79 €
041640-0	10W	FBK	4000K	800	36	SI 144*38	72,79 €
DALI/PUSH							
041596-D	10W	FW	2700K	800	36	SI 144*38	72,79 €
041602-D	10W	FW	3000K	800	36	SI 144*38	72,79 €
041619-D	10W	FW	4000K	800	36	SI 144*38	72,79 €
041626-D	10W	FBK	2700K	800	36	SI 144*38	72,79 €
041633-D	10W	FBK	3000K	800	36	SI 144*38	72,79 €
041640-D	10W	FBK	4000K	800	36	SI 144*38	72,79 €

ACCESORIOS/ACCESSORIES

REF.	DESCRIPCIÓN	P.V.P.
022816	10W-REFLECTOR FBK	4,00 €

ÓPTICAS/OPTICS

REF.	DESCRIPCIÓN	P.V.P.
	10W-LENS 15°	6,00 €
	10W-LENS 45°	6,00 €

SERIES INTEGRA ORIENTABLE - KED776 - 20W

REF.	POW.	ACABADO	CCT	LM	ANG.	OSCILANTE CUT (mm)	P.V.P
041657	20W	FW	2700K	1600	36	SI 262*38	57,36 €
041664	20W	FW	3000K	1600	36	SI 262*38	57,36 €
041671	20W	FW	4000K	1600	36	SI 262*38	57,36 €
041688	20W	FBK	2700K	1600	36	SI 262*38	57,36 €
041695	20W	FBK	3000K	1600	36	SI 262*38	57,36 €
041701	20W	FBK	4000K	1600	36	SI 262*38	57,36 €

REGULACIONES/DIMMING

REF.	POW.	ACABADO	CCT	LM	ANG.	OSCILANTE CUT (mm)	P.V.P.
TRIAC							
041657-T	20W	FW	2700K	1600	36	SI 262*38	92,36 €
041664-T	20W	FW	3000K	1600	36	SI 262*38	92,36 €
041671-T	20W	FW	4000K	1600	36	SI 262*38	92,36 €
041688-T	20W	FBK	2700K	1600	36	SI 262*38	92,36 €
041695-T	20W	FBK	3000K	1600	36	SI 262*38	92,36 €
041701-T	20W	FBK	4000K	1600	36	SI 262*38	92,36 €
0-10V							
041657-0	20W	FW	2700K	1600	36	SI 262*38	92,36 €
041664-0	20W	FW	3000K	1600	36	SI 262*38	92,36 €
041671-0	20W	FW	4000K	1600	36	SI 262*38	92,36 €
041688-0	20W	FBK	2700K	1600	36	SI 262*38	92,36 €
041695-0	20W	FBK	3000K	1600	36	SI 262*38	92,36 €
041701-0	20W	FBK	4000K	1600	36	SI 262*38	92,36 €
DALI/PUSH							
041657-D	20W	FW	2700K	1600	36	SI 262*38	92,36 €
041664-D	20W	FW	3000K	1600	36	SI 262*38	92,36 €
041671-D	20W	FW	4000K	1600	36	SI 262*38	92,36 €
041688-D	20W	FBK	2700K	1600	36	SI 262*38	92,36 €
041695-D	20W	FBK	3000K	1600	36	SI 262*38	92,36 €
041701-D	20W	FBK	4000K	1600	36	SI 262*38	92,36 €

ACCESORIOS/ACCESSORIES

REF.	DESCRIPCIÓN	P.V.P.
022823	20W-REFLECTOR FBK	7,00 €

ÓPTICAS/OPTICS

REF.	DESCRIPCIÓN	P.V.P.
022830	20W-LENS 15°	10,00 €
022830	20W-LENS 45°	10,00 €

SERIES INTEGRA TRIMLESS



Al **5W** **10W** **20W** **400 LUMEN** **800 LUMEN** **1600 LUMEN** **2.700°K** **3.000°K** **4.000°K** **15°** **36°** **45°** **AC 100V 240V**

Hz 50/60 **CRI >95** **PF >0.9** **UGR <17** **NO FLICKERING** **IP20 RATED** **RoHS COMPLIANT** **5 AÑOS GARANTÍA**

DIMENSIONES DIMENSIONS

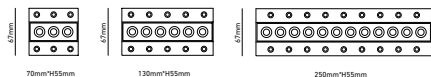

FOTOMETRÍA PHOTOMETRY

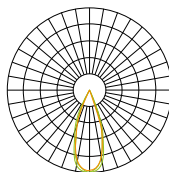

ACABADOS FINISHES



REGULACIÓN DIMMING

TRIAC - 0-10V - DALI

*** CASAMBI A CONSULTAR**

SERIES INTEGRA TRIMLESS - KED776 - 5W

REF.	POW.	ACABADO	CCT	LM	ANG.	OSCILANTE CUT (mm)	P.V.P
041718	5W	FW	2700K	400	36	NO 70*30	32,99 €
041725	5W	FW	3000K	400	36	NO 70*30	32,99 €
041732	5W	FW	4000K	400	36	NO 70*30	32,99 €
041749	5W	FBK	2700K	400	36	NO 70*30	32,99 €
041756	5W	FBK	3000K	400	36	NO 70*30	32,99 €
041763	5W	FBK	4000K	400	36	NO 70*30	32,99 €

REGULACIONES/DIMMING

REF.	POW.	ACABADO	CCT	LM	ANG.	OSCILANTE CUT (mm)	P.V.P.
TRIAC							
041718-T	5W	FW	2700K	400	36	NO 70*30	67,99 €
041725-T	5W	FW	3000K	400	36	NO 70*30	67,99 €
041732-T	5W	FW	4000K	400	36	NO 70*30	67,99 €
041749-T	5W	FBK	2700K	400	36	NO 70*30	67,99 €
041756-T	5W	FBK	3000K	400	36	NO 70*30	67,99 €
041763-T	5W	FBK	4000K	400	36	NO 70*30	67,99 €
0-10V							
041718-0	5W	FW	2700K	400	36	NO 70*30	67,99 €
041725-0	5W	FW	3000K	400	36	NO 70*30	67,99 €
041732-0	5W	FW	4000K	400	36	NO 70*30	67,99 €
041749-0	5W	FBK	2700K	400	36	NO 70*30	67,99 €
041756-0	5W	FBK	3000K	400	36	NO 70*30	67,99 €
041763-0	5W	FBK	4000K	400	36	NO 70*30	67,99 €
DALI/PUSH							
041718-D	5W	FW	2700K	400	36	NO 70*30	67,99 €
041725-D	5W	FW	3000K	400	36	NO 70*30	67,99 €
041732-D	5W	FW	4000K	400	36	NO 70*30	67,99 €
041749-D	5W	FBK	2700K	400	36	NO 70*30	67,99 €
041756-D	5W	FBK	3000K	400	36	NO 70*30	67,99 €
041763-D	5W	FBK	4000K	400	36	NO 70*30	67,99 €

ACCESORIOS/ACCESSORIES

REF.	DESCRIPCIÓN	P.V.P.
022847	5W-REFLECTOR FBK	3,00 €

ÓPTICAS/OPTICS

REF.	DESCRIPCIÓN	P.V.P.
022854	5W-LENS 15°	3,00 €
022861	5W-LENS 45°	3,00 €

SERIES INTEGRA TRIMLESS - KED776 - 10W

REF.	POW.	ACABADO	CCT	LM	ANG.	OSCILANTE CUT (mm)	P.V.P
041770	10W	FW	2700K	800	36	NO 130*30	40,79 €
041787	10W	FW	3000K	800	36	NO 130*30	40,79 €
041794	10W	FW	4000K	800	36	NO 130*30	40,79 €
041800	10W	FBK	2700K	800	36	NO 130*30	40,79 €
041817	10W	FBK	3000K	800	36	NO 130*30	40,79 €
041824	10W	FBK	4000K	800	36	NO 130*30	40,79 €

REGULACIONES/DIMMING

REF.	POW.	ACABADO	CCT	LM	ANG.	OSCILANTE CUT (mm)	P.V.P
TRIAC							
041770-T	10W	FW	2700K	800	36	NO 130*30	75,77 €
041787-T	10W	FW	3000K	800	36	NO 130*30	75,77 €
041794-T	10W	FW	4000K	800	36	NO 130*30	75,77 €
041800-T	10W	FBK	2700K	800	36	NO 130*30	75,77 €
041817-T	10W	FBK	3000K	800	36	NO 130*30	75,77 €
041824-T	10W	FBK	4000K	800	36	NO 130*30	75,77 €
0-10V							
041770-0	10W	FW	2700K	800	36	NO 130*30	75,77 €
041787-0	10W	FW	3000K	800	36	NO 130*30	75,77 €
041794-0	10W	FW	4000K	800	36	NO 130*30	75,77 €
041800-0	10W	FBK	2700K	800	36	NO 130*30	75,77 €
041817-0	10W	FBK	3000K	800	36	NO 130*30	75,77 €
041824-0	10W	FBK	4000K	800	36	NO 130*30	75,77 €
DALI/PUSH							
041770-D	10W	FW	2700K	800	36	NO 130*30	75,77 €
041787-D	10W	FW	3000K	800	36	NO 130*30	75,77 €
041794-D	10W	FW	4000K	800	36	NO 130*30	75,77 €
041800-D	10W	FBK	2700K	800	36	NO 130*30	75,77 €
041817-D	10W	FBK	3000K	800	36	NO 130*30	75,77 €
041824-D	10W	FBK	4000K	800	36	NO 130*30	75,77 €

ACCESORIOS/ACCESSORIES

REF.	DESCRIPCIÓN	P.V.P.
022878	10W-REFLECTOR FBK	4,00 €

ÓPTICAS/OPTICS

REF.	DESCRIPCIÓN	P.V.P.
022885	10W-LENS 15°	6,00 €
022892	10W-LENS 45°	6,00 €

SERIES INTEGRA TRIMLESS - KED776 - 20W

REF.	POW.	ACABADO	CCT	LM	ANG.	OSCILANTE CUT (mm)	P.V.P
041831	20W	FW	2700K	1600	36	NO 250*30	61,36 €
041848	20W	FW	3000K	1600	36	NO 250*30	61,36 €
041855	20W	FW	4000K	1600	36	NO 250*30	61,36 €
041862	20W	FBK	2700K	1600	36	NO 250*30	61,36 €
041879	20W	FBK	3000K	1600	36	NO 250*30	61,36 €
041886	20W	FBK	4000K	1600	36	NO 250*30	61,36 €

REGULACIONES/DIMMING

REF.	POW.	ACABADO	CCT	LM	ANG.	OSCILANTE CUT (mm)	P.V.P
TRIAC							
041831-T	20W	FW	2700K	1600	36	NO 250*30	96,36 €
041848-T	20W	FW	3000K	1600	36	NO 250*30	96,36 €
041855-T	20W	FW	4000K	1600	36	NO 250*30	96,36 €
041862-T	20W	FBK	2700K	1600	36	NO 250*30	96,36 €
041879-T	20W	FBK	3000K	1600	36	NO 250*30	96,36 €
041886-T	20W	FBK	4000K	1600	36	NO 250*30	96,36 €
0-10V							
041831-0	20W	FW	2700K	1600	36	NO 250*30	96,36 €
041848-0	20W	FW	3000K	1600	36	NO 250*30	96,36 €
041855-0	20W	FW	4000K	1600	36	NO 250*30	96,36 €
041862-0	20W	FBK	2700K	1600	36	NO 250*30	96,36 €
041879-0	20W	FBK	3000K	1600	36	NO 250*30	96,36 €
041886-0	20W	FBK	4000K	1600	36	NO 250*30	96,36 €
DALI/PUSH							
041831-D	20W	FW	2700K	1600	36	NO 250*30	96,36 €
041848-D	20W	FW	3000K	1600	36	NO 250*30	96,36 €
041855-D	20W	FW	4000K	1600	36	NO 250*30	96,36 €
041862-D	20W	FBK	2700K	1600	36	NO 250*30	96,36 €
041879-D	20W	FBK	3000K	1600	36	NO 250*30	96,36 €
041886-D	20W	FBK	4000K	1600	36	NO 250*30	96,36 €

ACCESORIOS/ACCESSORIES

REF.	DESCRIPCIÓN	P.V.P.
022908	20W-REFLECTOR FBK	7,00 €

ÓPTICAS/OPTICS

REF.	DESCRIPCIÓN	P.V.P.
022915	20W-LENS 15°	10,00 €
022922	20W-LENS 45°	10,00 €

SERIES LC013



Al **3W** **10W** **20W** **160 LUMEN** **780 LUMEN** **1400 LUMEN** **2.700°K** **3.000°K** **30°** **38x38mm** **135x35mm** **270x35mm** **AC 220V 240V** **UGR <17**
L80 B20 **Hz 50/60** **50.000h** **NO FLICKERING** **IP20 RATED** **MACADAM <3** **CRI >80** **RoHS COMPLIANT** **CE** **5 AÑOS GARANTÍA** **CREE** **KGP**

DIMENSIONES DIMENSIONS

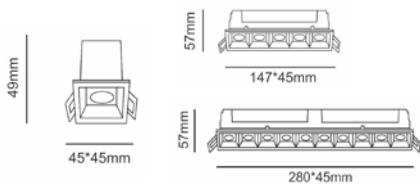

FOTOMETRÍA PHOTOMETRY

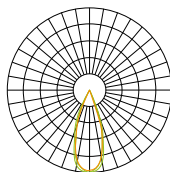

ACABADOS FINISHES



REGULACIÓN DIMMING

TRIAC - 0-10V - DALI

* CASAMBI A CONSULTAR

SERIES LC013 - 3W

REF.	POW.	ACABADO	CCT	LM	ANG.	OSCILANTE CUT (mm)	P.V.P
041893	3W	FW+FBK	2700K	160	36	NO 38*38	19,33 €
027927	3W	FW+FBK	3000K	160	36	NO 38*38	19,33 €

REGULACIONES/DIMMING

REF.	POW.	ACABADO	CCT	LM	ANG.	OSCILANTE CUT (mm)	P.V.P
TRIAC							
041893-T	3W	FW+FBK	2700K	160	30	NO 38*38	54,33 €
027927-T	3W	FW+FBK	3000K	160	30	NO 38*38	54,33 €

0-10V							
041893-0	3W	FW+FBK	2700K	160	30	NO 38*38	54,33 €
027927-0	3W	FW+FBK	3000K	160	30	NO 38*38	54,33 €

DALI/PUSH							
041893-D	3W	FW+FBK	2700K	160	30	NO 38*38	54,33 €
027927-D	3W	FW+FBK	3000K	160	30	NO 38*38	54,33 €

SERIES LC013 - 10W

REF.	POW.	ACABADO	CCT	LM	ANG.	OSCILANTE CUT (mm)	P.V.P
041909	10W	FW+FBK	2700K	780	30	NO 135*35	41,47 €
027934	10W	FW+FBK	3000K	780	30	NO 135*35	41,47 €

REGULACIONES/DIMMING

REF.	POW.	ACABADO	CCT	LM	ANG.	OSCILANTE CUT (mm)	P.V.P
TRIAC							
041909-T	10W	FW+FBK	2700K	780	30	NO 135*35	76,47 €
027934-T	10W	FW+FBK	3000K	780	30	NO 135*35	76,47 €

0-10V							
041909-0	10W	FW+FBK	2700K	780	30	NO 135*35	76,47 €
027934-0	10W	FW+FBK	3000K	780	30	NO 135*35	76,47 €

DALI/PUSH							
041909-D	10W	FW+FBK	2700K	780	30	NO 135*35	76,47 €
027934-D	10W	FW+FBK	3000K	780	30	NO 135*35	76,47 €

SERIES LC013 - 20W

REF.	POW.	ACABADO	CCT	LM	ANG.	OSCILANTE CUT (mm)	P.V.P
041916	20W	FW+FBK	2700K	1400	30	NO 135*35	72,76 €
027941	20W	FW+FBK	3000K	1400	30	NO 135*35	72,76 €

REGULACIONES/DIMMING

REF.	POW.	ACABADO	CCT	LM	ANG.	OSCILANTE CUT (mm)	P.V.P
TRIAC							
041916-T	20W	FW+FBK	2700K	1400	30	NO 135*35	107,65 €
027941-T	20W	FW+FBK	3000K	1400	30	NO 135*35	107,65 €

0-10V							
041916-0	20W	FW+FBK	2700K	1400	30	NO 135*35	107,65 €
027941-0	20W	FW+FBK	3000K	1400	30	NO 135*35	107,65 €

DALI/PUSH							
041916-D	20W	FW+FBK	2700K	1400	30	NO 135*35	107,65 €
027941-D	20W	FW+FBK	3000K	1400	30	NO 135*35	107,65 €

SERIES LC1428

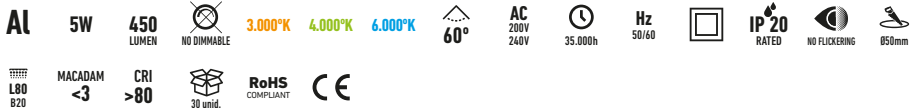

DIMENSIONES DIMENSIONS



FOTOMETRÍA PHOTOMETRY

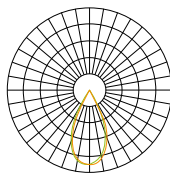

ACABADOS FINISHES



REGULACIÓN DIMMING

SERIES LC1428 - 5W - REDONDO

REF.	POW.	ACABADO	CCT	LM	ANG.	OSCILANTE CUT (mm)	P.V.P
001095	5W	W	3000K	450	60	NO Ø50	15,91 €
001101	5W	W	4000K	450	60	NO Ø50	15,91 €
001118	5W	W	6000K	450	60	NO Ø50	15,91 €

SERIES LC1428 - 5W - CUADRADO

REF.	POW.	ACABADO	CCT	LM	ANG.	OSCILANTE CUT (mm)	P.V.P
001187	5W	W	3000K	450	60	NO Ø50	16,20 €
001194	5W	W	4000K	450	60	NO Ø50	16,20 €
001200	5W	W	6000K	450	60	NO Ø50	16,20 €

SERIES LC1431



Al

7W

600
LUMEN

3.000°K

4.000°K

6.000°K

60°

AC
220V
240V

35.000h

Hz
50/60



IP 20
RATED



NO FLICKERING



Ø50mm

L80
B20

MACADAM
<3

CRI
>80



30 unid.

RoHS
COMPLIANT



DIMENSIONES DIMENSIONS

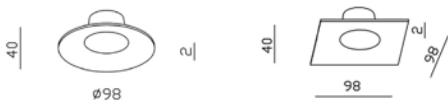

FOTOMETRÍA PHOTOMETRY

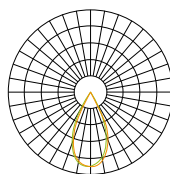

ACABADOS FINISHES

FW

REGULACIÓN DIMMING

TRIAC - 0-10V - DALI

* CASAMBI A CONSULTAR

SERIES LC1431 - 7W - REDONDO

REF.	POW.	ACABADO	CCT	LM	ANG.	OSCILANTE	CUT (mm)	P.V.P.
001361	7W	W	3000K	600	60	NO	Ø50	19,31 €
001378	7W	W	4000K	600	60	NO	Ø50	19,31 €
001385	7W	W	6000K	600	60	NO	Ø50	19,31 €

REGULACIONES/DIMMING

REF.	POW.	ACABADO	CCT	LM	ANG.	OSCILANTE	CUT (mm)	P.V.P.
TRIAC								
001361-T	7W	W	3000K	600	60	NO	Ø50	54,31 €
001378T	7W	W	4000K	600	60	NO	Ø50	54,31 €
001385T	7W	W	6000K	600	60	NO	Ø50	54,31 €
0-10V								
001361-0	7W	W	3000K	600	60	NO	Ø50	54,31 €
001378-0	7W	W	4000K	600	60	NO	Ø50	54,31 €
001385-0	7W	W	6000K	600	60	NO	Ø50	54,31 €
DALI/PUSH								
001361-D	7W	W	3000K	600	60	NO	Ø50	54,31 €
001378-D	7W	W	4000K	600	60	NO	Ø50	54,31 €
001385-D	7W	W	6000K	600	60	NO	Ø50	54,31 €

SERIES LC1431 - 7W - CUADRADO

REF.	POW.	ACABADO	CCT	LM	ANG.	OSCILANTE	CUT (mm)	P.V.P.
001453	7W	W	3000K	600	60	NO	Ø50	19,58 €
001460	7W	W	4000K	600	60	NO	Ø50	19,58 €
001477	7W	W	6000K	600	60	NO	Ø50	19,58 €

REGULACIONES/DIMMING

REF.	POW.	ACABADO	CCT	LM	ANG.	OSCILANTE	CUT (mm)	P.V.P.
TRIAC								
001453-T	7W	W	3000K	600	60	NO	Ø50	54,58 €
001460-T	7W	W	4000K	600	60	NO	Ø50	54,58 €
001477-T	7W	W	6000K	600	60	NO	Ø50	54,58 €
0-10V								
001453-0	7W	W	3000K	600	60	NO	Ø50	54,58 €
001460-0	7W	W	4000K	600	60	NO	Ø50	54,58 €
001477-0	7W	W	6000K	600	60	NO	Ø50	54,58 €
DALI/PUSH								
001453-D	7W	W	3000K	600	60	NO	Ø50	54,58 €
001460-D	7W	W	4000K	600	60	NO	Ø50	54,58 €
001477-D	7W	W	6000K	600	60	NO	Ø50	54,58 €

SERIES LC3193



SELECTOR CCT
 Sistema para elegir la temperatura de color mediante interruptor. Permite seleccionar entre blanco cálido (3000K), neutro (3500K) y frío (4000K).

Al

AC
100V
240V

CCT

3000°K
3500°K
4000°K

3.000°K

3.500°K

4.000°K

10W

900
LUMEN

60°

35.000h

Hz
50/60

CRI
>90

IP 20
RATED

NO FLICKERING

RoHS
COMPLIANT

CE

3 AÑOS
GARANTIA

KGP

DIMENSIONES DIMENSIONS

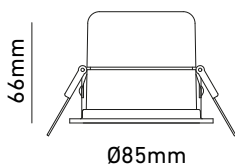

FOTOMETRÍA PHOTOMETRY

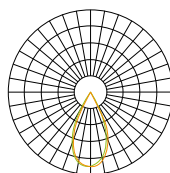

ACABADOS FINISHES



REGULACIÓN DIMMING

REF.	POW.	ACABADO	CCT	LM	ANG.	OSCILANTE	CUT (mm)	P.V.P
038251	10W	FW	3000K 3500K 4000K	900	60	NO	Ø75	14,59 €
038411	10W	FBK	3000K 3500K 4000K	900	60	NO	Ø75	14,59 €

SERIES LC1444



Al

4W

320
LUMEN



120°

3.000°K 4.000°K



Ø65 mm

AC
220V
240V

35.000h

Hz
50/60



IP44
RATED



NO FLICKERING

L80
B20

MACADAM
<3

CRI
>80



30 unid.

RoHS
COMPLIANT



DIMENSIONES DIMENSIONS



FOTOMETRÍA PHOTOMETRY

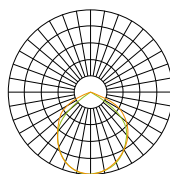

ACABADOS FINISHES



REGULACIÓN DIMMING

REF.	POW.	ACABADO	CCT	LM	ANG.	OSCILANTE CUT (mm)	P.V.P
017546	4W	BK	3000K	320	120	NO Ø80	17,62 €
017553	4W	BK	4000K	320	120	NO Ø80	17,62 €
017515	4W	CH	3000K	320	120	NO Ø80	17,62 €
017522	4W	CH	4000K	320	120	NO Ø80	17,62 €
005895	4W	W	3000K	320	120	NO Ø80	16,36 €
005901	4W	W	4000K	320	120	NO Ø80	16,36 €

SERIES LC1445



DIMENSIONES DIMENSIONS

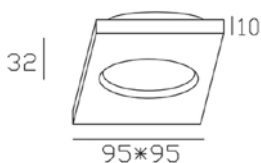

FOTOMETRÍA PHOTOMETRY

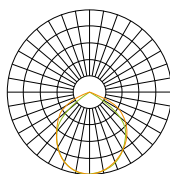

ACABADOS FINISHES



REGULACIÓN DIMMING

REF.	POW.	ACABADO	CCT	LM	ANG.	OSCILANTE	CUT (mm)	P.V.P
017423	7W	BK	3000K	320	120	NO	Ø75	27,64 €
017430	7W	BK	4000K	320	120	NO	Ø75	27,64 €
005956	7W	CH	3000K	320	120	NO	Ø75	27,64 €
005963	7W	CH	4000K	320	120	NO	Ø75	27,64 €
005925	7W	W	3000K	320	120	NO	Ø75	26,11 €

SERIES LC1452



DIMENSIONES DIMENSIONS



FOTOMETRÍA PHOTOMETRY

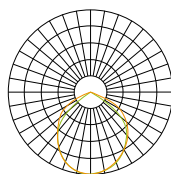

ACABADOS FINISHES



REGULACIÓN DIMMING

REF.	POW.	ACABADO	CCT	LM	ANG.	OSCILANTE CUT (mm)	P.V.P
017577	7W	BK	3000K	560	120	NO Ø75	20,92 €
021994	7W	G	3000K	560	120	NO Ø75	21,81 €
022182	7W	G	4000K	560	120	NO Ø75	21,81 €
005833	7W	W	3000K	560	120	NO Ø75	20,29 €
005840	7W	W	4000K	560	120	NO Ø76	20,29 €

SERIES LC1427



AI

AC
200V
240V

3.000°K

4.000°K

6.000°K

120°

35.000h

Hz
50/60



IP54
RATED



NO FLICKERING

L80
B20

MACADAM
<3

CRI
>80

RoHS
COMPLIANT



DIMENSIONES DIMENSIONS

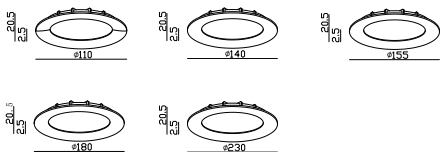

ACABADOS FINISHES



FOTOMETRÍA PHOTOMETRY

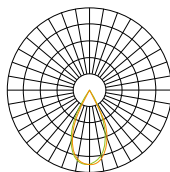

REGULACIÓN DIMMING

TRIAC - 0-10V - DALI

* CASAMBI A CONSULTAR

SERIES LC1427 - 9W

REF.	POW.	ACABADO	CCT	LM	ANG.	OSCILANTE CUT (mm)		P.V.P
006557	9W	W	3000K	700	120	NO	Ø90	23,55 €
006564	9W	W	4000K	700	120	NO	Ø90	23,55 €

REGULACIONES/DIMMING

REF.	POW.	ACABADO	CCT	LM	ANG.	OSCILANTE CUT (mm)		P.V.P.
TRIAC								
006557-T	9W	W	3000K	700	120	NO	Ø90	58,55 €
006564-T	9W	W	4000K	700	120	NO	Ø90	58,55 €
0-10V								
006557-0	9W	W	3000K	700	120	NO	Ø90	58,55 €
006564-0	9W	W	4000K	700	120	NO	Ø90	58,55 €
DALI/PUSH								
006557-D	9W	W	3000K	700	120	NO	Ø90	58,55 €
006564-D	9W	W	4000K	700	120	NO	Ø90	58,55 €

SERIES LC1427 - 11W

REF.	POW.	ACABADO	CCT	LM	ANG.	OSCILANTE CUT (mm)		P.V.P
006588	11W	W	3000K	880	120	NO	Ø125	28,86 €
006595	11W	W	4000K	880	120	NO	Ø125	28,86 €
019229	11W	FBK	4000K	880	120	NO	Ø125	28,86 €

REGULACIONES/DIMMING

REF.	POW.	ACABADO	CCT	LM	ANG.	OSCILANTE CUT (mm)		P.V.P.
TRIAC								
006588-T	11W	W	3000K	880	120	NO	Ø125	63,86 €
006595-T	11W	W	4000K	880	120	NO	Ø125	63,86 €
019229-T	11W	FBK	4000K	880	120	NO	Ø125	63,86 €
0-10V								
006588-0	11W	W	3000K	880	120	NO	Ø125	63,86 €
006595-0	11W	W	4000K	880	120	NO	Ø125	63,86 €
019229-0	11W	FBK	4000K	880	120	NO	Ø125	63,86 €
DALI/PUSH								
006588D	11W	W	3000K	880	120	NO	Ø125	63,86 €
006595-D	11W	W	4000K	880	120	NO	Ø125	63,86 €
019229-D	11W	FBK	4000K	880	120	NO	Ø125	63,86 €

SERIES LC1427 - 15W

REF.	POW.	ACABADO	CCT	LM	ANG.	OSCILANTE CUT (mm)	P.V.P
006618	15W	W	3000K	1200	120	NO Ø140	31,28 €
006625	15W	W	4000K	1200	120	NO Ø140	31,28 €
019250	15W	FBK	4000K	1200	120	NO Ø140	31,28 €

REGULACIONES/DIMMING

REF.	POW.	ACABADO	CCT	LM	ANG.	OSCILANTE CUT (mm)	P.V.P.
TRIAC							
006618-T	15W	W	3000K	1200	120	NO Ø140	66,28 €
006625-T	15W	W	4000K	1200	120	NO Ø140	66,28 €
019250-T	15W	FBK	4000K	1200	120	NO Ø140	66,28 €
0-10V							
006618-0	15W	W	3000K	1200	120	NO Ø140	66,28 €
006625-0	15W	W	4000K	1200	120	NO Ø140	66,28 €
019250-0	15W	FBK	4000K	1200	120	NO Ø140	66,28 €
DALI/PUSH							
006618-D	15W	W	3000K	1200	120	NO Ø140	66,28 €
006625-D	15W	W	4000K	1200	120	NO Ø140	66,28 €
019250-D	15W	FBK	4000K	1200	120	NO Ø140	66,28 €

SERIES LC1427 - 18W

REF.	POW.	ACABADO	CCT	LM	ANG.	OSCILANTE CUT (mm)	P.V.P
006649	18W	W	3000K	1440	120	NO Ø160	39,85 €
006656	18W	W	4000K	1440	120	NO Ø160	39,85 €
019298	18W	FBK	4000K	1440	120	NO Ø160	39,85 €

REGULACIONES/DIMMING

REF.	POW.	ACABADO	CCT	LM	ANG.	OSCILANTE CUT (mm)	P.V.P.
TRIAC							
006649-T	18W	W	3000K	1440	120	NO Ø160	74,85 €
006656-T	18W	W	4000K	1440	120	NO Ø160	74,85 €
019298-T	18W	FBK	4000K	1440	120	NO Ø160	74,85 €
0-10V							
006649-0	18W	W	3000K	1440	120	NO Ø160	74,85 €
006656-0	18W	W	4000K	1440	120	NO Ø160	74,85 €
019298-0	18W	FBK	4000K	1440	120	NO Ø160	74,85 €
DALI/PUSH							
006649-D	18W	W	3000K	1440	120	NO Ø160	74,85 €
006656-D	18W	W	4000K	1440	120	NO Ø160	74,85 €
019298-D	18W	FBK	4000K	1440	120	NO Ø160	74,85 €

SERIES LC1427 - 23W

REF.	POW.	ACABADO	CCT	LM	ANG.	OSCILANTE CUT (mm)		P.V.P
006670	23W	W	3000K	1840	120	NO	Ø210	51,92 €
006687	23W	W	4000K	1840	120	NO	Ø210	51,92 €
006694	23W	W	6000K	1840	120	NO	Ø210	51,92 €
019328	23W	FBK	4000K	1840	120	NO	Ø210	51,92 €

REGULACIONES/DIMMING

REF.	POW.	ACABADO	CCT	LM	ANG.	OSCILANTE CUT (mm)		P.V.P
TRIAC								
006670-T	23W	W	3000K	1840	120	NO	Ø210	86,92 €
006687-T	23W	W	4000K	1840	120	NO	Ø210	86,92 €
006694-T	23W	W	6000K	1840	120	NO	Ø210	86,92 €
019328-T	23W	FBK	4000K	1840	120	NO	Ø210	86,92 €
0-10V								
006670-0	23W	W	3000K	1840	120	NO	Ø210	86,92 €
006687-0	23W	W	4000K	1840	120	NO	Ø210	86,92 €
006694-0	23W	W	6000K	1840	120	NO	Ø210	86,92 €
019328-0	23W	FBK	4000K	1840	120	NO	Ø210	86,92 €
DALI/PUSH								
006670-D	23W	W	3000K	1840	120	NO	Ø210	86,92 €
006687-D	23W	W	4000K	1840	120	NO	Ø210	86,92 €
006694-D	23W	W	6000K	1840	120	NO	Ø210	86,92 €
019328-D	23W	FBK	4000K	1840	120	NO	Ø210	86,92 €

SERIES LC1483



Al	AC 200V 240V	11W	15W	18W	23W	880 LUMEN	1.200 LUMEN	1.440 LUMEN	1.840 LUMEN	35.000h	3.000°K	4.000°K	120°	IP20 RATED
Ø115 mm	Ø130 mm	Ø150 mm	Ø200 mm		NO FLICKERING	L80 B20	Hz 50/60	MACADAM <3	CRI >80	RoHS COMPLIANT				

DIMENSIONES DIMENSIONS

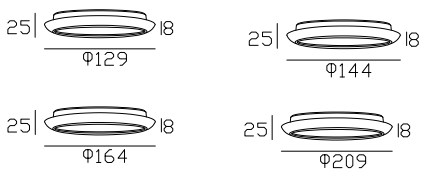

ACABADOS FINISHES



FOTOMETRÍA PHOTOMETRY

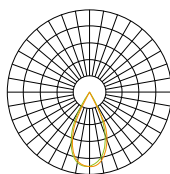

REGULACIÓN DIMMING

TRIAC - 0-10V - DALI

* CASAMBI A CONSULTAR

SERIES LC1483 - 11W

REF.	POW.	ACABADO	CCT	LM	ANG.	OSCILANTE CUT (mm)	P.V.P
007097	11W	CH	3000K	880	120	NO Ø115	32,49 €
007073	11W	CH	4000K	880	120	NO Ø115	32,49 €

REGULACIONES/DIMMING

REF.	POW.	ACABADO	CCT	LM	ANG.	OSCILANTE CUT (mm)	P.V.P
TRIAC							
007097-T	11W	CH	3000K	880	120	NO Ø115	67,49 €
007073-T	11W	CH	4000K	880	120	NO Ø115	67,49 €
0-10V							
007097-0	11W	CH	3000K	880	120	NO Ø115	67,49 €
007073-0	11W	CH	4000K	880	120	NO Ø115	67,49 €
DALI/PUSH							
007097-D	11W	CH	3000K	880	120	NO Ø115	67,49 €
007073-D	11W	CH	4000K	880	120	NO Ø115	67,49 €

SERIES LC1483 - 15W

REF.	POW.	ACABADO	CCT	LM	ANG.	OSCILANTE CUT (mm)	P.V.P
022199	15w	CH	3000K	1200	120	NO Ø130	35,39 €
007134	15w	CH	4000K	1200	120	NO Ø130	35,39 €

REGULACIONES/DIMMING

REF.	POW.	ACABADO	CCT	LM	ANG.	OSCILANTE CUT (mm)	P.V.P
TRIAC							
022199-T	15w	CH	3000K	1200	120	NO Ø130	70,39 €
007134-T	15w	CH	4000K	1200	120	NO Ø130	70,39 €
0-10V							
022199-0	15w	CH	3000K	1200	120	NO Ø130	70,39 €
007134-0	15w	CH	4000K	1200	120	NO Ø130	70,39 €
DALI/PUSH							
022199-D	15w	CH	3000K	1200	120	NO Ø130	70,39 €
007134-D	15w	CH	4000K	1200	120	NO Ø130	70,39 €

ACCESORIOS/ACCESSORIES

REF.	DESCRIPCIÓN	P.V.P
022939	ACC. LC1883-11W-ARO GOLD	1,00 €
022946	ACC. LC1883-15W-ARO GOLD	1,50 €
022953	ACC. LC1883-18W-ARO GOLD	2,00 €
022960	ACC. LC1883-23W-ARO GOLD	2,50 €

SERIES LC1483 - 18W

REF.	POW.	ACABADO	CCT	LM	ANG.	OSCILANTE CUT (mm)	P.V.P
017843	18W	CH	3000K	1440	120	NO Ø150	48,30 €
007165	18W	CH	4000K	1440	120	NO Ø150	48,30 €

REGULACIONES/DIMMING

REF.	POW.	ACABADO	CCT	LM	ANG.	OSCILANTE CUT (mm)	P.V.P.
TRIAC							
017843-T	18W	CH	3000K	1440	120	NO Ø150	83,30 €
007165-T	18W	CH	4000K	1440	120	NO Ø150	83,30 €
0-10V							
017843-0	18W	CH	3000K	1440	120	NO Ø150	83,30 €
007165-0	18W	CH	4000K	1440	120	NO Ø150	83,30 €
DALI/PUSH							
017843-D	18W	CH	3000K	1440	120	NO Ø150	83,30 €
007165-D	18W	CH	4000K	1440	120	NO Ø150	83,30 €

SERIES LC1483 - 23W

REF.	POW.	ACABADO	CCT	LM	ANG.	OSCILANTE CUT (mm)	P.V.P
007240	23W	CH	3000K	1840	120	NO Ø200	62,19 €
007226	23W	CH	4000K	1840	120	NO Ø200	62,19 €

REGULACIONES/DIMMING

REF.	POW.	ACABADO	CCT	LM	ANG.	OSCILANTE CUT (mm)	P.V.P.
TRIAC							
007240-T	23W	CH	3000K	1840	120	NO Ø200	97,19 €
007226-T	23W	CH	4000K	1840	120	NO Ø200	97,19 €
0-10V							
007240-0	23W	CH	3000K	1840	120	NO Ø200	97,19 €
007226-0	23W	CH	4000K	1840	120	NO Ø200	97,19 €
DALI/PUSH							
007240-D	23W	CH	3000K	1840	120	NO Ø200	97,19 €
007226-D	23W	CH	4000K	1840	120	NO Ø200	97,19 €

SERIES LC1453

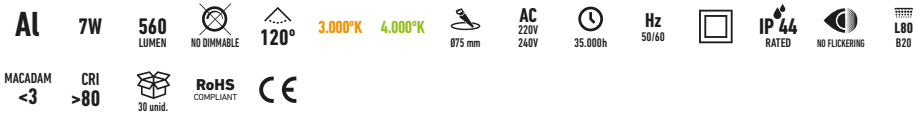

DIMENSIONES DIMENSIONS

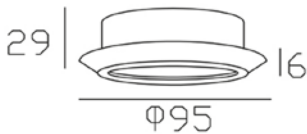

FOTOMETRÍA PHOTOMETRY

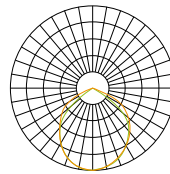

ACABADOS FINISHES



REGULACIÓN DIMMING

REF.	POW.	ACABADO	CCT	LM	ANG.	OSCILANTE CUT (mm)	P.V.P
017485	7W	BK	3000K	560	120	NO Ø75	21,68 €
017454	7W	CH	3000K	560	120	NO Ø75	21,68 €
017461	7W	CH	4000K	560	120	NO Ø75	21,68 €
005819	7W	W	4000K	560	120	NO Ø75	20,29 €

SERIES BASIC CCT



SELECTOR CCT
 Sistema para elegir la temperatura de color mediante interruptor. Permite seleccionar entre blanco cálido (3000K), neutro (4000K) y frío (5700K).



30.000h



ON/OFF
x 25.000



AC
220V
240V



Hz
50/60



NO DIMMABLE

3.000°K

4.000°K

5.700°K



IP 20
RATED



NO FLICKERING



CRI
>80



RoHS
COMPLIANT

DIMENSIONES DIMENSIONS

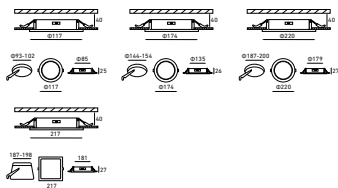

FOTOMETRÍA PHOTOMETRY

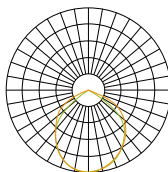

ACABADOS FINISHES



REGULACIÓN DIMMING

DOWNLIGHT EMPOTRABLE REDONDO CCT TERMOPLÁSTICO

REF.	POW.	ACABADO	CCT	LM	ANG.	OSCILANTE	CUT (mm)	P.V.P
041923	6W	W	3000K 4000K 5700K	490	120	NO	Ø95-106	3,95 €
041930	12W	W	3000K 4000K 5700K	1155	120	NO	Ø145-160	6,59 €
041947	18W	W	3000K 4000K 5700K	1830	120	NO	Ø189-207	8,79 €

DOWNLIGHT EMPOTRABLE CUADRADO CCT TERMOPLÁSTICO

REF.	POW.	ACABADO	CCT	LM	ANG.	OSCILANTE	CUT (mm)	P.V.P
042722	18W	W	3000K 4000K 5700K	1830	120	NO	190-207	8,86 €

SERIES PANEL LED

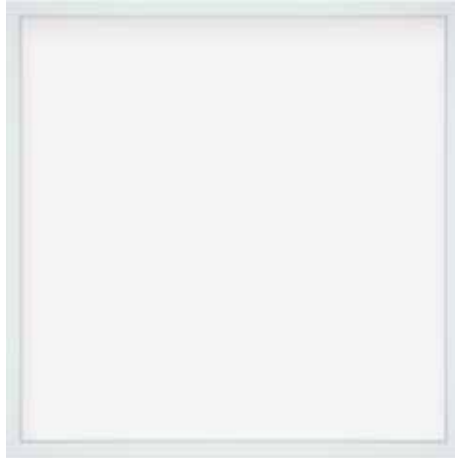

AC
220V
240V

40W

4300
LUMEN

4.000°K 5.700°K

120°

IP 20
RATED

UGR
<19

NO DIMMABLE

NO FLICKERING

PF
>0.9

CRI
80

Hz
50/60

50.000h

5 unid.



RoHS
COMPLIANT

5 AÑOS
GARANTÍA

LIFUD



DIMENSIONES DIMENSIONS

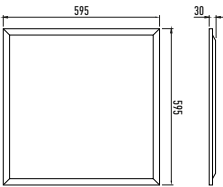

ACABADOS FINISHES



FOTOMETRÍA PHOTOMETRY

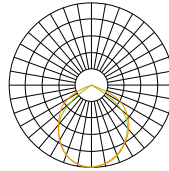

REGULACIÓN DIMMING

TRIAC - 0-10V - DALI

* CASAMBI A CONSULTAR

PL 60X60 40W

REF.	POW.	ACABADO	CCT	LM	ANG.	CRI	UGR	P.V.P
031955	40	W	4000K	4300	120°	80	<19	41,48 €
031962	40	W	5700K	4300	120°	80	<19	41,48 €

REGULACIONES/DIMMING

REF.	POW.	ACABADO	CCT	LM	ANG.	CRI	UGR	P.V.P.
TRIAC								
031955-T	40	W	4000K	4300	120°	80	<19	76,48 €
031962-T	40	W	5700K	4300	120°	80	<19	76,48 €
0-10V								
031955-0	40	W	4000K	4300	120°	80	<19	76,48 €
031962-0	40	W	5700K	4300	120°	80	<19	76,48 €
DALI/PUSH								
031955-D	40	W	4000K	4300	120°	80	<19	76,48 €
031962-D	40	W	5700K	4300	120°	80	<19	76,48 €

ACCESORIOS/ACCESSORIES

REF.	DESCRIPCIÓN	P.V.P.
991204	ACC. KIT SUPERFICIE PANEL 60X60X6 BLANCO	22,90 €
031757	ACC. MARCO EMPOTRAR PANEL 60X60X6 BLANCO	24,66 €

4.

DOWNLIGHT
DE SUPERFICIE
DOWNLIGHT
SURFACE

SERIES LC1400



AI **5W** **400 LUMEN** **60°** **AC 220V 240V** **Hz 50/60** **3.000°K** **IP 20 RATED** **MACADAM <3** **CRI >80**

RoHS COMPLIANT

DIMENSIONES DIMENSIONS

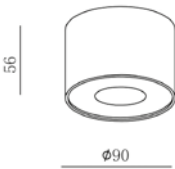

FOTOMETRÍA PHOTOMETRY

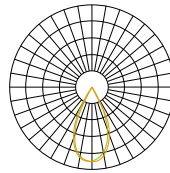

ACABADOS FINISHES



REGULACIÓN DIMMING

REF.	POW.	ACABADO	CCT	LM	ANG.	OSCILANTE	CUT (mm)	P.V.P
008117	5W	W	3000K	400	60	NO	20	21,37 €
008209	5W	FBK	3000K	400	60	NO	20	21,37 €

SERIES LC1312

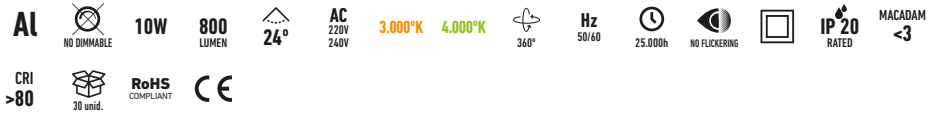

DIMENSIONES DIMENSIONS

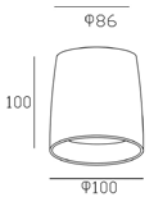

ACABADOS FINISHES



FOTOMETRÍA PHOTOMETRY

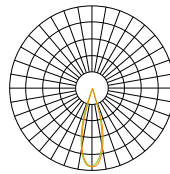

REGULACIÓN DIMMING

REF.	POW.	ACABADO	CCT	LM	ANG.	OSCILANTE	CUT (mm)	P.V.P
009268	10W	W	3000K	800	24	NO	20	48,00 €
009275	10W	W	4000K	800	24	NO	20	48,00 €
009206	10W	CH	3000K	800	24	NO	20	54,46 €
009213	10W	CH	4000K	800	24	NO	20	54,46 €

SERIES BASIC CCT



SELECTOR CCT

Sistema para elegir la temperatura de color mediante interruptor. Permite seleccionar entre blanco cálido (3000K), neutro (4000K) y frío (5700K).



30.000h



ON/OFF
x 25.000



AC
220V
240V



Hz
50/60



NO DIMMABLE

3.000°K

4.000°K

5.700°K



IP20
RATED



NO FLICKERING



CRI
>80



CE

RoHS
COMPLIANT

DIMENSIONES DIMENSIONS

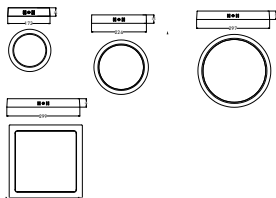

ACABADOS FINISHES



FOTOMETRÍA PHOTOMETRY

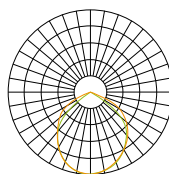

REGULACIÓN DIMMING

DOWNLIGHT SUPERFICIE REDONDO CCT TERMOPLÁSTICO

REF.	POW.	ACABADO	CCT	LM	ANG.	OSCILANTE	IP	P.V.P
042197	9W	W	3000K 4000K 5700K	820	120	NO	20	5,26 €
042203	12W	W	3000K 4000K 5700K	1155	120	NO	20	7,76 €
042210	18W	W	3000K 4000K 5700K	1830	120	NO	20	10,01 €

DOWNLIGHT SUPERFICIE CUADRADO CCT TERMOPLÁSTICO

REF.	POW.	ACABADO	CCT	LM	ANG.	OSCILANTE	IP	P.V.P
042739	18W	W	3000K 4000K 5700K	1830	120	NO	20	9,56 €

5.

LÁMPARAS
SERIES LC
LC SERIES
LAMPS

SERIES LC1282



Al 10W 800 LUMEN 24° AC 220V 240V 3.000°K 4.000°K Hz 50/60 35.000h PF >0.95 NO FLICKERING IP 20 RATED MACADAM <3 CRI >80

12 unid. RoHS COMPLIANT CE EAGLERISE

DIMENSIONES DIMENSIONS



ACABADOS FINISHES



FOTOMETRÍA PHOTOMETRY

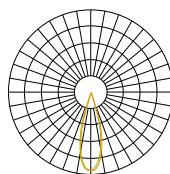

REGULACIÓN DIMMING

TRIAC - 0-10V - DALI

* CASAMBI A CONSULTAR

SERIES LC1282 - 10W

REF.	POW.	ACABADO	CCT	LM	ANG.	CRI	IP	P.V.P.
009442	10W	W	3000K	800	24°	>80	20	62,02 €
009459	10W	W	4000K	800	24°	>80	20	62,02 €
022410	10W	BK	3000K	800	24°	>80	20	72,65 €
009503	10W	CH	3000K	800	24°	>80	20	72,65 €
009510	10W	CH	4000K	800	24°	>80	20	72,65 €

REGULACIONES/DIMMING

REF.	POW.	ACABADO	CCT	LM	ANG.	CRI	IP	P.V.P.
TRIAC								
009442-T	10W	W	3000K	800	24°	>80	20	97,02 €
009459-T	10W	W	4000K	800	24°	>80	20	97,02 €
022410-T	10W	BK	3000K	800	24°	>80	20	107,65 €
009503-T	10W	CH	3000K	800	24°	>80	20	107,65 €
009510-T	10W	CH	4000K	800	24°	>80	20	107,65 €
0-10V								
009442-0	10W	W	3000K	800	24°	>80	20	97,02 €
009459-0	10W	W	4000K	800	24°	>80	20	97,02 €
022410-0	10W	BK	3000K	800	24°	>80	20	107,65 €
009503-0	10W	CH	3000K	800	24°	>80	20	107,65 €
009510-0	10W	CH	4000K	800	24°	>80	20	107,65 €
DALI								
009442-D	10W	W	3000K	800	24°	>80	20	97,02 €
009459-D	10W	W	4000K	800	24°	>80	20	97,02 €
022410-D	10W	BK	3000K	800	24°	>80	20	107,65 €
009503-D	10W	CH	3000K	800	24°	>80	20	107,65 €
009510-D	10W	CH	4000K	800	24°	>80	20	107,65 €

SERIES LC1283



Al 10W 800 LUMEN 24° AC 220V 240V 3.000°K 4.000°K Hz 50/60 35.000h PF >0.95 NO FLICKERING IP 20 RATED MACADAM <3 CRI >80

12 unid. RoHS COMPLIANT CE EAGLE RISE

DIMENSIONES DIMENSIONS



ACABADOS FINISHES



FOTOMETRÍA PHOTOMETRY

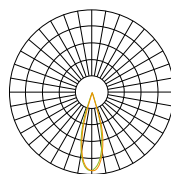

REGULACIÓN DIMMING

TRIAC - 0-10V - DALI

* CASAMBI A CONSULTAR

SERIES LC1283 - 10W

REF.	POW.	ACABADO	CCT	LM	ANG.	CRI	IP	P.V.P.
009565	10W	W	3000K	800	24°	>80	20	77,27 €
009572	10W	W	4000K	800	24°	>80	20	77,27 €
022434	10W	BK	3000K	800	24°	>80	20	101,99 €
009688	10W	CH	3000K	800	24°	>80	20	101,99 €
009695	10W	CH	4000K	800	24°	>80	20	101,99 €

REGULACIONES/DIMMING

REF.	POW.	ACABADO	CCT	LM	ANG.	CRI	IP	P.V.P.
TRIAC								
009565-T	10W	W	3000K	800	24°	>80	20	107,27 €
009572-T	10W	W	4000K	800	24°	>80	20	107,27 €
022434-T	10W	BK	3000K	800	24°	>80	20	136,99 €
009688-T	10W	CH	3000K	800	24°	>80	20	136,99 €
009695-T	10W	CH	4000K	800	24°	>80	20	136,99 €
0-10V								
009565-0	10W	W	3000K	800	24°	>80	20	107,27 €
009572-0	10W	W	4000K	800	24°	>80	20	107,27 €
022434-0	10W	BK	3000K	800	24°	>80	20	136,99 €
009688-0	10W	CH	3000K	800	24°	>80	20	136,99 €
009695-0	10W	CH	4000K	800	24°	>80	20	136,99 €
DALI								
009565-D	10W	W	3000K	800	24°	>80	20	107,27 €
009572-D	10W	W	4000K	800	24°	>80	20	107,27 €
022434-D	10W	BK	3000K	800	24°	>80	20	136,99 €
009688-D	10W	CH	3000K	800	24°	>80	20	136,99 €
009695-D	10W	CH	4000K	800	24°	>80	20	136,99 €

SERIES LC1284



Al 10W 800 LUMEN 24° AC 220V 240V 3.000°K 4.000°K Hz 50/60 35.000h PF >0.95 NO FLICKERING IP 20 RATED MACADAM <3 CRI >80

12 unid. RoHS COMPLIANT CE EAGLE RISE

DIMENSIONES DIMENSIONS

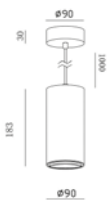

ACABADOS FINISHES



FOTOMETRÍA PHOTOMETRY

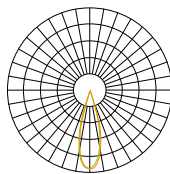

REGULACIÓN DIMMING

TRIAC - 0-10V - DALI

* CASAMBI A CONSULTAR

SERIES LC1284 - 10W

REF.	POW.	ACABADO	CCT	LM	ANG.	CRI	IP	P.V.P.
009749	10W	W	3000K	800	24°	>80	20	71,96 €
009756	10W	W	4000K	800	24°	>80	20	71,96 €
009862	10W	CH	3000K	800	24°	>80	20	84,20 €
009879	10W	CH	4000K	800	24°	>80	20	84,20 €

REGULACIONES/DIMMING

REF.	POW.	ACABADO	CCT	LM	ANG.	CRI	IP	P.V.P.
TRIAC								
009749-T	10W	W	3000K	800	24°	>80	20	106,96 €
009756-T	10W	W	4000K	800	24°	>80	20	106,96 €
009862-T	10W	CH	3000K	800	24°	>80	20	119,20 €
009879-T	10W	CH	4000K	800	24°	>80	20	119,20 €

0-10V								
009749-0	10W	W	3000K	800	24°	>80	20	106,96 €
009756-0	10W	W	4000K	800	24°	>80	20	106,96 €
009862-0	10W	CH	3000K	800	24°	>80	20	119,20 €
009879-0	10W	CH	4000K	800	24°	>80	20	119,20 €

DALI								
009749-D	10W	W	3000K	800	24°	>80	20	106,96 €
009756-D	10W	W	4000K	800	24°	>80	20	106,96 €
009862-D	10W	CH	3000K	800	24°	>80	20	119,20 €
009879-D	10W	CH	4000K	800	24°	>80	20	119,20 €

SERIES LC1285

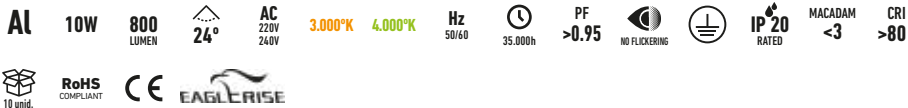

DIMENSIONES DIMENSIONS



ACABADOS FINISHES



FOTOMETRÍA PHOTOMETRY

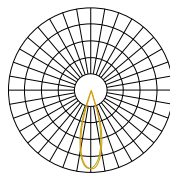

REGULACIÓN DIMMING

TRIAC - 0-10V - DALI

* CASAMBI A CONSULTAR

SERIES LC1285 - 10W

REF.	POW.	ACABADO	CCT	LM	ANG.	CRI	IP	P.V.P.
009923	10W	W	3000K	800	24°	>80	20	87,20 €
009930	10W	W	4000K	800	24°	>80	20	87,20 €
018864	10W	CH	3000K	800	24°	>80	20	114,23 €
018871	10W	CH	4000K	800	24°	>80	20	114,23 €

REGULACIONES/DIMMING

REF.	POW.	ACABADO	CCT	LM	ANG.	CRI	IP	P.V.P.
TRIAC								
009923-T	10W	W	3000K	800	24°	>80	20	122,20 €
009930-T	10W	W	4000K	800	24°	>80	20	122,20 €
018864-T	10W	CH	3000K	800	24°	>80	20	149,23 €
018871-T	10W	CH	4000K	800	24°	>80	20	149,23 €

0-10V								
009923-0	10W	W	3000K	800	24°	>80	20	122,20 €
009930-0	10W	W	4000K	800	24°	>80	20	122,20 €
018864-0	10W	CH	3000K	800	24°	>80	20	149,23 €
018871-0	10W	CH	4000K	800	24°	>80	20	149,23 €

DALI								
009923-D	10W	W	3000K	800	24°	>80	20	122,20 €
009930-D	10W	W	4000K	800	24°	>80	20	122,20 €
018864-D	10W	CH	3000K	800	24°	>80	20	149,23 €
018871-D	10W	CH	4000K	800	24°	>80	20	149,23 €

6.

SERIES
NC GU10
NC GU10
SERIES

SERIES NC1800-M - SUPERFICIE



DIMENSIONES DIMENSIONS

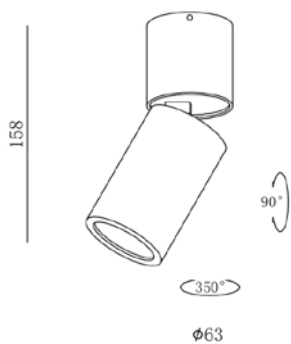

ACABADOS FINISHES



REF.	ACABADO	DIMENSIONES (mm)	FORMATO	OSCILANTE	IP	P.V.P.
026630	FBK	Ø63X158	REDONDO	SI	20	34,06 €
010110	W	Ø63X158	REDONDO	SI	20	34,06 €
010134	CH	Ø63X158	REDONDO	SI	20	38,73 €
021536	Q	Ø63X158	REDONDO	SI	20	38,73 €

SERIES NC1801-M - SUPERFICIE



DIMENSIONES DIMENSIONS

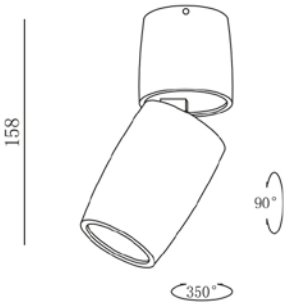

ACABADOS FINISHES



REF.	ACABADO	DIMENSIONES (mm)	FORMATO	OSCILANTE	IP	P.V.P.
010141	W	Ø63X158	REDONDO	SI	20	36,47 €
022212	BK	Ø63X158	REDONDO	SI	20	41,40 €
022205	CH	Ø63X158	REDONDO	SI	20	41,40 €

SERIES NC2156 - EMPOTRABLE



Al

IP 20
RATED



GU10



30 unid.

RoHS
COMPLIANT



INCLUDED

DIMENSIONES DIMENSIONS



93*93mm

ACABADOS FINISHES

FW

FBK



REF.	ACABADO	DIMENSIONES (mm)	FORMATO	OSCILANTE	IP	P.V.P.
024001	FW	Ø93X133	REDONDO	SI	20	36,54 €
025060	FBK	Ø93X133	REDONDO	SI	20	36,54 €

SERIES NC2187 - SUPERFICIE



DIMENSIONES DIMENSIONS



Ø60mm

ACABADOS FINISHES



REF.	ACABADO	DIMENSIONES (mm)	FORMATO	OSCILANTE	IP	P.V.P.
025770	FW	Ø60X400	REDONDO	NO	20	36,54 €
025756	FBK	Ø60X400	REDONDO	NO	20	36,54 €

SERIES NC2188 - COLGANTE



DIMENSIONES DIMENSIONS

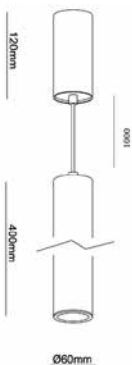

ACABADOS FINISHES



REF.	ACABADO	DIMENSIONES (mm)	FORMATO	OSCILANTE	IP	P.V.P.
025695	FW	Ø60X1520	REDONDO	NO	20	59,85 €
025633	FBK	Ø60X1520	REDONDO	NO	20	59,85 €

SERIES NC1936 - SUPERFICIE



DIMENSIONES DIMENSIONS

ACABADOS FINISHES

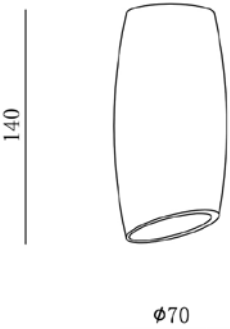

REF.	ACABADO	DIMENSIONES (mm)	FORMATO	OSCILANTE	IP	P.V.P.
022236	BK	Ø70X140	REDONDO	NO	20	35,66 €
010158	W	Ø70X140	REDONDO	NO	20	28,85 €
010165	CH	Ø70X140	REDONDO	NO	20	35,66 €

SERIES NC1942 - SUPERFICIE



DIMENSIONES DIMENSIONS

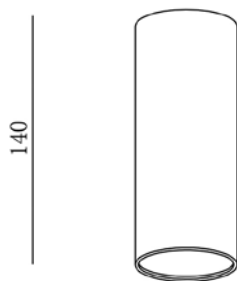

Ø60

ACABADOS FINISHES



REF.	ACABADO	DIMENSIONES (mm)	FORMATO	OSCILANTE	IP	P.V.P.
010172	W	Ø60X140	REDONDO	NO	20	21,84 €
021550	FBK	Ø60X140	REDONDO	NO	20	21,84 €
010189	CH	Ø60X140	REDONDO	NO	20	27,85 €

SERIES NC1942-80 - SUPERFICIE



Al

IP 20
RATED



GU10



30 unid.

RoHS
COMPLIANT



INCLUDED

DIMENSIONES DIMENSIONS

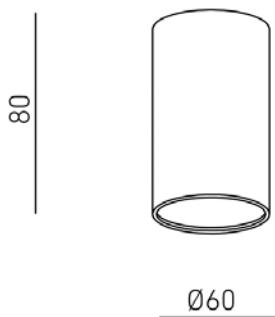

ACABADOS FINISHES



REF.	ACABADO	DIMENSIONES (mm)	FORMATO	OSCILANTE	IP	P.V.P.
031559	FW	Ø60X80	REDONDO	NO	20	18,73 €
031566	FBK	Ø60X80	REDONDO	NO	20	18,73 €

SERIES NC1949 - COLGANTE



DIMENSIONES DIMENSIONS

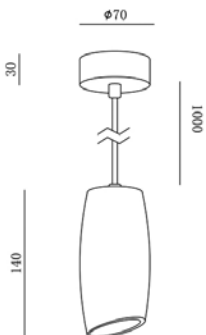

ACABADOS FINISHES



REF.	ACABADO	DIMENSIONES (mm)	FORMATO	OSCILANTE	IP	P.V.P.
010240	W	Ø70X140	REDONDO	NO	20	34,52 €
022229	CH	Ø70X140	REDONDO	NO	20	41,45 €

SERIES NC1955 - COLGANTE



DIMENSIONES DIMENSIONS

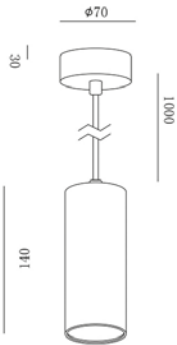

ACABADOS FINISHES



REF.	ACABADO	DIMENSIONES (mm)	FORMATO	OSCILANTE	IP	P.V.P.
010233	W	Ø60X140	REDONDO	NO	20	25,07 €
032266	FBK	Ø60X140	REDONDO	NO	20	25,07 €
017607	CH	Ø60X140	REDONDO	NO	20	31,00 €

SERIES NC1968 - SUPERFICIE



DIMENSIONES DIMENSIONS

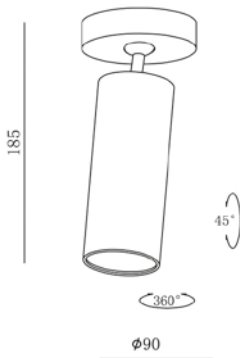

ACABADOS FINISHES



REF.	ACABADO	DIMENSIONES (mm)	FORMATO	OSCILANTE	IP	P.V.P.
010219	W	Ø90X185	REDONDO	SI	20	33,89 €
010226	CH	Ø90X185	REDONDO	SI	20	41,45 €

SERIES NC1962 - SUPERFICIE



DIMENSIONES DIMENSIONS

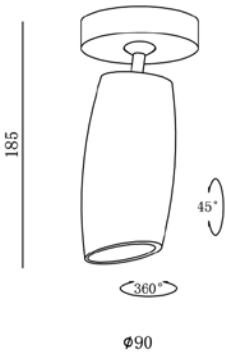

ACABADOS FINISHES



REF.	ACABADO	DIMENSIONES (mm)	FORMATO	OSCILANTE	IP	P.V.P.
010196	W	Ø90X185	REDONDO	SI	20	43,09 €
022519	FBK	Ø90X185	REDONDO	SI	20	43,09 €
022243	CH	Ø90X185	REDONDO	SI	20	51,53 €

SERIES NC1746 - WALL LIGHT



Al

IP 20
RATED



GU10

30 unid.

RoHS
COMPLIANT



INCLUDED

DIMENSIONES DIMENSIONS

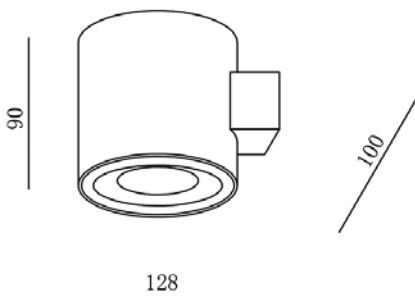

ACABADOS FINISHES



REF.	ACABADO	DIMENSIONES (mm)	FORMATO	OSCILANTE	IP	P.V.P.
010080	FBK+W	Ø128X90	REDONDO	NO	20	35,15 €
010066	W+FBK	Ø128X90	REDONDO	NO	20	35,15 €
010073	FBK+CH	Ø128X90	REDONDO	NO	20	43,97 €

SERIES NC1747 - SUPERFICIE



DIMENSIONES DIMENSIONS

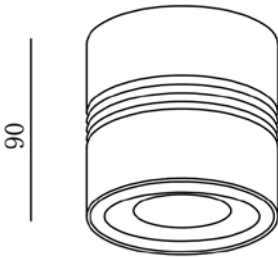

Ø100

ACABADOS FINISHES



REF.	ACABADO	DIMENSIONES (mm)	FORMATO	OSCILANTE	IP	P.V.P.
010103	W+FBK	Ø100X90	REDONDO	NO	20	25,07 €
010097	CH+FBK	Ø100X90	REDONDO	NO	20	30,11 €

SERIES NC1464-R95 - SUPERFICIE REDONDO



DIMENSIONES DIMENSIONS

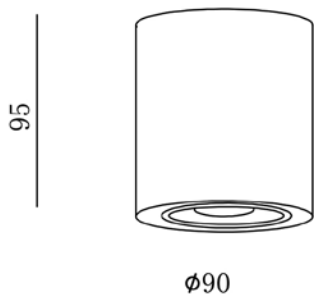

ACABADOS FINISHES



REF.	ACABADO	DIMENSIONES (mm)	FORMATO	OSCILANTE	IP	P.V.P.
017812	FBK	Ø90X95	REDONDO	NO	20	28,98 €
017805	FW	Ø90X95	REDONDO	NO	20	28,98 €
017720	CH	Ø90X95	REDONDO	NO	20	42,21 €

SERIES NC1464-SQ95 - SUPERFICIE CUADRADO



DIMENSIONES DIMENSIONS

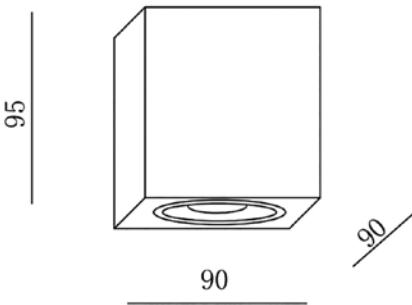

ACABADOS FINISHES



REF.	ACABADO	DIMENSIONES (mm)	FORMATO	OSCILANTE	IP	P.V.P.
017768	FBK	90X90X95	CUADRADO	NO	20	49,75 €
017751	FW	90X90X95	CUADRADO	NO	20	49,75 €
017775	CH	90X90X95	CUADRADO	NO	20	55,57 €

7.1.

**AROS DE
ALUMINIO TECH**
TECH ALUMINIUM
RECESSED RINGS

SERIE CONFORT



- Al
- IP 20
RATED
- IP 54
RATED
- 060mm
- GU10
- 30 unid.
- RoHS
COMPLIANT
- CE
- G10 INCLUDED

DIMENSIONES DIMENSIONS

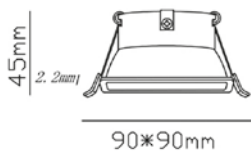
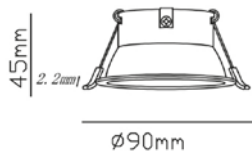

ACABADOS FINISHES



ACCESORIOS ACCESSORIES

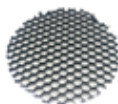

Accesorio
Panel Abeja

NC2152 REDONDO

REF.	ACABADO	DIMENSIONES (mm)	ØCUT (mm)	FORMATO	OSCILANTE	IP	P.V.P.
022373	FW	Ø90X45	Ø80	REDONDO	NO	20	7,93 €
023318	FBK	Ø90X45	Ø80	REDONDO	NO	20	7,93 €
037940	GY	Ø90X45	Ø80	REDONDO	NO	20	7,93 €

NC2152 REDONDO IP54

REF.	ACABADO	DIMENSIONES (mm)	ØCUT (mm)	FORMATO	OSCILANTE	IP	P.V.P.
029235	FW	Ø90X45	Ø80	REDONDO	NO	54	9,56 €
029242	FBK	Ø90X45	Ø80	REDONDO	NO	54	9,56 €
002351	GY	Ø90X45	Ø80	REDONDO	NO	54	9,56 €

NC2152 CUADRADO

REF.	ACABADO	DIMENSIONES (mm)	ØCUT (mm)	FORMATO	OSCILANTE	IP	P.V.P.
022380	FW	90X90X45	80X80	REDONDO	NO	20	8,22 €
022632	FBK	90X90X46	80X80	REDONDO	NO	20	8,22 €

NC913L ASIMÉTRICO

REF.	ACABADO	DIMENSIONES (mm)	ØCUT (mm)	FORMATO	OSCILANTE	IP	P.V.P.
022991	FW	Ø95X60	Ø85	ASIMÉTRICO	NO	20	11,59 €
026623	FBK	Ø95X60	Ø85	ASIMÉTRICO	NO	20	11,59 €

ACCESORIOS/ACCESSORIES

REF.	DESCRIPCIÓN	P.V.P.
032730	ACCESORIO PANEL DE ABEJA	1,10 €

SERIE CONFORT ORIENTABLE



Al

IP 20
RATED

IP 54
RATED



GU10



RoHS
COMPLIANT



DIMENSIONES DIMENSIONS

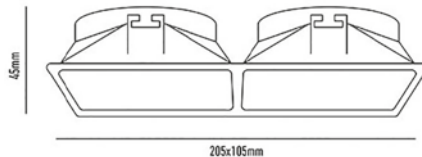
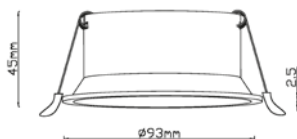

ACABADOS FINISHES



ACCESORIOS ACCESSORIES

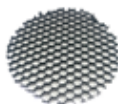

Accesorio
Panel Abeja

NC1201 REDONDO

REF.	ACABADO	DIMENSIONES (mm)	ØCUT (mm)	FORMATO	OSCILANTE	IP	P.V.P.
028993	FW	Ø93X45	Ø85	REDONDO	SI	20	8,81 €
029006	FBK	Ø93X45	Ø85	REDONDO	SI	20	8,81 €

NC894L CUADRADO DOBLE

REF.	ACABADO	DIMENSIONES (mm)	ØCUT (mm)	FORMATO	OSCILANTE	IP	P.V.P.
023127	FW	205X105X45	195X95	REDONDO	SI	20	20,45 €
026616	FBK	205X105X46	195X96	REDONDO	SI	20	20,45 €

ACCESORIOS/ACCESSORIES

REF.	DESCRIPCIÓN	P.V.P.
032730	ACCESORIO PANEL DE ABEJA	1,10 €

SERIE ALA ANCHA



DIMENSIONES DIMENSIONS

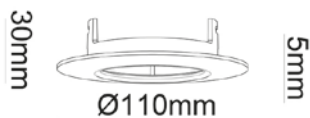
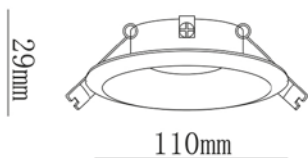

ACABADOS FINISHES



ACCESORIOS ACCESSORIES

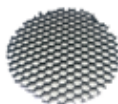

Accesorio
Panel Abeja

NC2160 REDONDO

REF.	ACABADO	DIMENSIONES (mm)	ØCUT (mm)	FORMATO	OSCILANTE	IP	P.V.P.
022656	FW	Ø110X29	Ø65	REDONDO	NO	20	8,66 €
022649	FBK	Ø110X29	Ø65	REDONDO	NO	20	8,66 €
037957	GY	Ø110X29	Ø65	REDONDO	NO	20	8,66 €

NC2161 REDONDO

REF.	ACABADO	DIMENSIONES (mm)	ØCUT (mm)	FORMATO	OSCILANTE	IP	P.V.P.
025602	FW	Ø110X30	Ø80	REDONDO	SI	20	11,59 €
026500	FBK	Ø110X30	Ø80	REDONDO	SI	20	11,59 €

ACCESORIOS/ACCESSORIES

REF.	DESCRIPCIÓN	P.V.P.
032730	ACCESORIO PANEL DE ABEJA	1,10 €

SERIE LUXA



Al

IP 20
RATED

IP 54
RATED



800mm

GU10

30 unid.

RoHS
COMPLIANT

CE

GU10 INCLUDED

DIMENSIONES DIMENSIONS

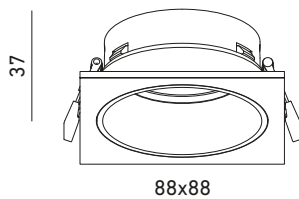
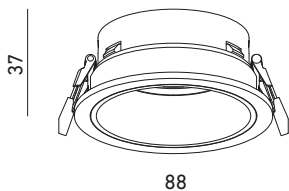

ACABADOS FINISHES



ACCESORIOS ACCESSORIES

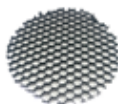

Accesorio
Panel Abeja

NC3018 REDONDO

REF.	ACABADO	DIMENSIONES (mm)	ØCUT (mm)	FORMATO	OSCILANTE	IP	P.V.P.
036578	FW	Ø88X37	Ø80	REDONDO	SI	20	8,84 €
036585	FBK	Ø88X37	Ø80	REDONDO	SI	20	8,84 €

NC3018 CUADRADO

REF.	ACABADO	DIMENSIONES (mm)	ØCUT (mm)	FORMATO	OSCILANTE	IP	P.V.P.
036592	FW	88X88X37	Ø80	CUADRADO	SI	20	8,84 €
036608	FBK	88X88X37	Ø80	CUADRADO	SI	20	8,84 €

ACCESORIOS/ACCESSORIES

REF.	DESCRIPCIÓN	P.V.P.
032730	ACCESORIO PANEL DE ABEJA	1,10 €

7.2.

**AROS DE
ALUMINIO DECO**
DECO ALUMINIUM
RINGS

SERIE NC1860



DIMENSIONES DIMENSIONS

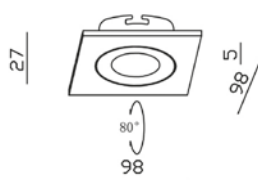
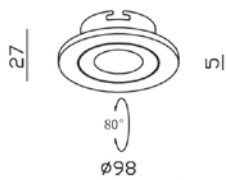

ACABADOS FINISHES

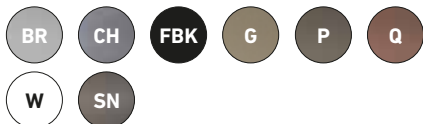

ACCESORIOS ACCESSORIES

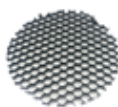

Accesorio
Panel Abeja

NC1860 REDONDO

REF.	ACABADO	DIMENSIONES (mm)	ØCUT (mm)	FORMATO	OSCILANTE	IP	P.V.P.
021338	BR	Ø98X27	Ø75	REDONDO	SI	20	16,65 €
000739	CH	Ø98X27	Ø75	REDONDO	SI	20	18,25 €
021345	FBK	Ø98X27	Ø75	REDONDO	SI	20	16,65 €
017638	G	Ø98X27	Ø75	REDONDO	SI	20	20,13 €
021314	P	Ø98X27	Ø75	REDONDO	SI	20	18,25 €
021321	Q	Ø98X27	Ø75	REDONDO	SI	20	18,25 €
000722	W	Ø98X27	Ø75	REDONDO	SI	20	16,65 €
027194	SN	Ø98X27	Ø75	REDONDO	SI	20	18,25 €

NC1860 CUADRADO

REF.	ACABADO	DIMENSIONES (mm)	ØCUT (mm)	FORMATO	OSCILANTE	IP	P.V.P.
021376	BR	98X98X27	Ø75	CUADRADO	SI	20	21,88 €
000753	CH	98X98X27	Ø75	CUADRADO	SI	20	23,90 €
021383	FBK	98X98X27	Ø75	CUADRADO	SI	20	21,88 €
021352	P	98X98X27	Ø75	CUADRADO	SI	20	23,90 €
021369	Q	98X98X27	Ø75	CUADRADO	SI	20	23,90 €
000746	W	98X98X27	Ø75	CUADRADO	SI	20	21,88 €
027200	SN	98X98X27	Ø75	CUADRADO	SI	20	23,90 €

ACCESORIOS/ACCESSORIES

REF.	DESCRIPCIÓN	P.V.P.
032730	ACCESORIO PANEL DE ABEJA	1,13 €

SERIE NC1855-S



Al

IP 20
RATED



865 mm

GU10

30 unid.

RoHS
COMPLIANT

CE

GU10 INCLUDED

DIMENSIONES DIMENSIONS

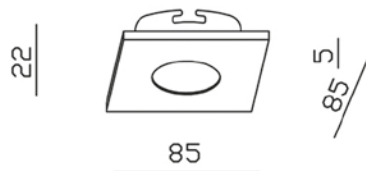
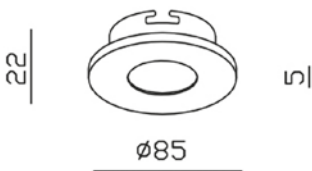

ACABADOS FINISHES

CH

W

ACCESORIOS ACCESSORIES

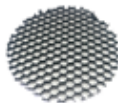

Accesorio
Panel Abeja

NC1855-S REDONDO

REF.	ACABADO	DIMENSIONES (mm)	ØCUT (mm)	FORMATO	OSCILANTE	IP	P.V.P.
000265	CH	Ø85X22	Ø65	REDONDO	NO	20	12,16 €
000258	W	Ø85X22	Ø65	REDONDO	NO	20	11,01 €

NC1855-S REDONDO IP54

REF.	ACABADO	DIMENSIONES (mm)	ØCUT (mm)	FORMATO	OSCILANTE	IP	P.V.P.
000289	CH	85X85X22	Ø65	CUADRADO	NO	20	14,51 €
000272	W	85X85X22	Ø65	CUADRADO	NO	20	13,36 €

NC1855-S CUADRADO

REF.	ACABADO	DIMENSIONES (mm)	ØCUT (mm)	FORMATO	OSCILANTE	IP	P.V.P.
000289	CH	85X85X22	Ø65	CUADRADO	NO	20	14,64 €
000272	W	85X85X22	Ø65	CUADRADO	NO	20	13,18 €

ACCESORIOS/ACCESSORIES

REF.	DESCRIPCIÓN	P.V.P.
032730	ACCESORIO PANEL DE ABEJA	1,10 €

SERIE NC1855-B



DIMENSIONES DIMENSIONS

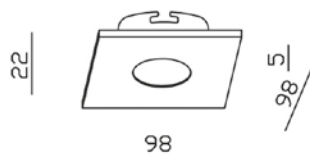
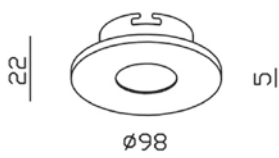

ACABADOS FINISHES



ACCESORIOS ACCESSORIES

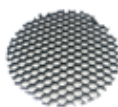

Accesorio
Panel Abeja

NC1855-B REDONDO

REF.	ACABADO	DIMENSIONES (mm)	ØCUT (mm)	FORMATO	OSCILANTE	IP	P.V.P.
021390	BR	Ø98X22	Ø70	REDONDO	NO	20	12,16 €
000302	CH	Ø98X22	Ø70	REDONDO	NO	20	13,92 €
021406	FBK	Ø98X22	Ø70	REDONDO	NO	20	12,16 €
019175	G	Ø98X22	Ø70	REDONDO	NO	20	14,64 €
021574	P	Ø98X22	Ø70	REDONDO	NO	20	13,92 €
021581	Q	Ø98X22	Ø70	REDONDO	NO	20	13,92 €
000296	W	Ø98X22	Ø70	REDONDO	NO	20	12,16 €
027224	SN	Ø98X22	Ø70	REDONDO	NO	20	13,92 €

NC1855-B REDONDO IP54

REF.	ACABADO	DIMENSIONES (mm)	ØCUT (mm)	FORMATO	OSCILANTE	IP	P.V.P.
002801	BR	Ø98X22	Ø70	REDONDO	NO	20	14,51 €
002894	CH	Ø98X22	Ø70	REDONDO	NO	20	16,27 €
003167	FBK	Ø98X22	Ø70	REDONDO	NO	20	14,51 €
003198	G	Ø98X22	Ø70	REDONDO	NO	20	16,99 €
003280	P	Ø98X22	Ø70	REDONDO	NO	20	16,27 €
003808	Q	Ø98X22	Ø70	REDONDO	NO	20	16,27 €
004065	W	Ø98X22	Ø70	REDONDO	NO	20	14,51 €
004157	SN	Ø98X22	Ø70	REDONDO	NO	20	16,27 €

NC1855-B CUADRADO

REF.	ACABADO	DIMENSIONES (mm)	ØCUT (mm)	FORMATO	OSCILANTE	IP	P.V.P.
021437	BR	98X98X22	Ø70	CUADRADO	NO	20	14,64 €
000326	CH	98X98X22	Ø70	CUADRADO	NO	20	16,97 €
021444	FBK	98X98X22	Ø70	CUADRADO	NO	20	14,64 €
015047	G	98X98X22	Ø70	CUADRADO	NO	20	18,25 €
021413	P	98X98X22	Ø70	CUADRADO	NO	20	16,97 €
021420	Q	98X98X22	Ø70	CUADRADO	NO	20	16,97 €
000319	W	98X98X22	Ø70	CUADRADO	NO	20	14,64 €
027231	SN	98X98X22	Ø70	CUADRADO	NO	20	16,97 €

ACCESORIOS/ACCESSORIES

REF.	DESCRIPCIÓN	P.V.P.
032730	ACCESORIO PANEL DE ABEJA	1,10 €

SERIE NC2002



DIMENSIONES DIMENSIONS

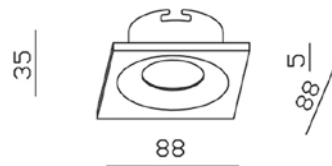
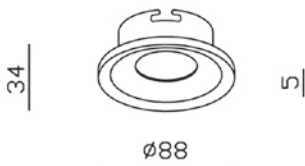

ACABADOS FINISHES



ACCESORIOS ACCESSORIES



Accesorio
Panel Abeja

NC2002 REDONDO

REF.	ACABADO	DIMENSIONES (mm)	ØCUT (mm)	FORMATO	OSCILANTE	IP	P.V.P.
000210	W	Ø88X34	Ø70	REDONDO	NO	20	10,72 €
000227	W+CH	Ø88X35	Ø70	REDONDO	NO	20	11,73 €

NC2002 CUADRADO

REF.	ACABADO	DIMENSIONES (mm)	ØCUT (mm)	FORMATO	OSCILANTE	IP	P.V.P.
000234	W	88X88X35	Ø70	CUADRADO	NO	20	11,01 €
000241	W+CH	88X88X35	Ø70	CUADRADO	NO	20	12,17 €

ACCESORIOS/ACCESSORIES

REF.	DESCRIPCIÓN	P.V.P.
032730	ACCESORIO PANEL DE ABEJA	1,10 €

SERIE NC1761

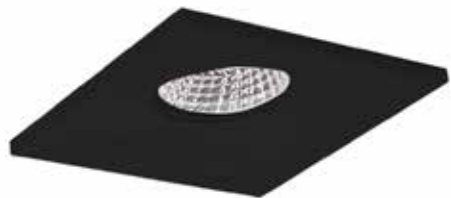

Al

IP 20
RATED

IP 54
RATED



GU10



RoHS
COMPLIANT



DIMENSIONES DIMENSIONS

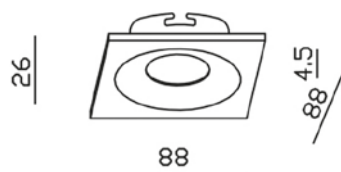
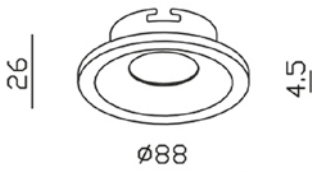

ACABADOS FINISHES



ACCESORIOS ACCESSORIES

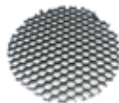

Accesorio
Panel Abeja

NC1761 REDONDO

REF.	ACABADO	DIMENSIONES (mm)	ØCUT (mm)	FORMATO	OSCILANTE	IP	P.V.P.
000531	W	Ø88X26	Ø70	REDONDO	NO	20	16,52 €
004249	FBK	Ø88X26	Ø70	REDONDO	NO	20	16,52 €

NC1761 REDONDO IP54

REF.	ACABADO	DIMENSIONES (mm)	ØCUT (mm)	FORMATO	OSCILANTE	IP	P.V.P.
004331	W	Ø88X26	Ø70	REDONDO	NO	20	18,87 €
004393	FBK	Ø88X26	Ø70	REDONDO	NO	20	18,87 €

NC1761 CUADRADO

REF.	ACABADO	DIMENSIONES (mm)	ØCUT (mm)	FORMATO	OSCILANTE	IP	P.V.P.
000500	W	88X88X26	Ø70	CUADRADO	NO	20	20,72 €
004423	FBK	88X88X26	Ø70	CUADRADO	NO	20	20,72 €

ACCESORIOS/ACCESSORIES

REF.	DESCRIPCIÓN	P.V.P.
032730	ACCESORIO PANEL DE ABEJA	1,10 €

SERIE NC1772



Al

IP 20
RATED



870 mm

GU10

30 unid.

RoHS
COMPLIANT

CE

GU10 INCLUDED

DIMENSIONES DIMENSIONS

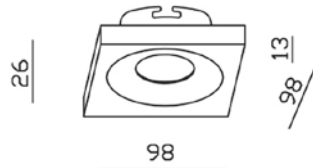
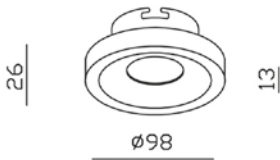

ACABADOS FINISHES

CH

W

ACCESORIOS ACCESSORIES

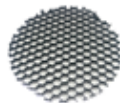

Accesorio
Panel Abeja

NC1772 REDONDO

REF.	ACABADO	DIMENSIONES (mm)	ØCUT (mm)	FORMATO	OSCILANTE	IP	P.V.P.
000623	CH	Ø98X26	Ø70	REDONDO	NO	20	23,49 €
000616	W	Ø98X26	Ø70	REDONDO	NO	20	22,17 €

NC1772 CUADRADO

REF.	ACABADO	DIMENSIONES (mm)	ØCUT (mm)	FORMATO	OSCILANTE	IP	P.V.P.
000593	CH	98X98X26	Ø70	CUADRADO	NO	20	30,13 €
000586	W	98X98X26	Ø70	CUADRADO	NO	20	27,97 €

ACCESORIOS/ACCESSORIES

REF.	DESCRIPCIÓN	P.V.P.
032730	ACCESORIO PANEL DE ABEJA	1,10 €

SERIE NC1765



Al

IP 20
RATED

IP 54
RATED



GU10

30 unid.

RoHS
COMPLIANT



GU10 INCLUDED

DIMENSIONES DIMENSIONS

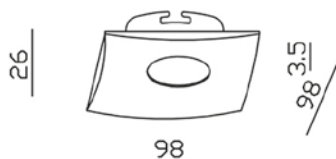
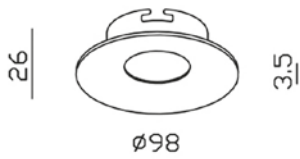

ACABADOS FINISHES



ACCESORIOS ACCESSORIES

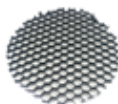

Accesorio
Panel Abeja

NC1765 REDONDO

REF.	ACABADO	DIMENSIONES (mm)	ØCUT (mm)	FORMATO	OSCILANTE	IP	P.V.P.
000487	CH	Ø98X26	Ø70	REDONDO	NO	20	20,00 €
000470	W	Ø98X26	Ø70	REDONDO	NO	20	18,12 €
014279	RC	Ø98X26	Ø70	REDONDO	NO	20	20,72 €

NC1765 REDONDO IP54

REF.	ACABADO	DIMENSIONES (mm)	ØCUT (mm)	FORMATO	OSCILANTE	IP	P.V.P.
004515	CH	Ø98X26	Ø70	REDONDO	NO	20	22,35 €
004690	W	Ø98X26	Ø70	REDONDO	NO	20	20,47 €
004782	RC	Ø98X26	Ø70	REDONDO	NO	20	23,07 €

NC1765 CUADRADO

REF.	ACABADO	DIMENSIONES (mm)	ØCUT (mm)	FORMATO	OSCILANTE	IP	P.V.P.
000432	CH	98X98X26	Ø70	CUADRADO	NO	20	25,21 €
000425	W	98X98X26	Ø70	CUADRADO	NO	20	22,61 €
000456	RC	98X98X26	Ø70	CUADRADO	NO	20	24,29 €

ACCESORIOS/ACCESSORIES

REF.	DESCRIPCIÓN	P.V.P.
032730	ACCESORIO PANEL DE ABEJA	1,10 €

SERIE NC1760



Al

IP 20
RATED



Ø70 mm

GU10

30 unid.

RoHS
COMPLIANT

CE

GU10 INCLUDED

DIMENSIONES DIMENSIONS

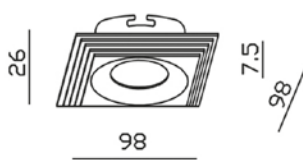
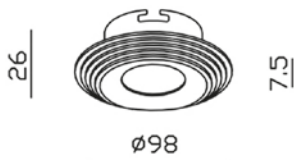

ACABADOS FINISHES

CH

W

RC

ACCESORIOS ACCESSORIES

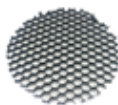

Accesorio
Panel Abeja

NC1760 REDONDO

REF.	ACABADO	DIMENSIONES (mm)	ØCUT (mm)	FORMATO	OSCILANTE	IP	P.V.P.
000654	CH	Ø98X26	Ø70	REDONDO	NO	20	20,85 €
000647	W	Ø98X26	Ø70	REDONDO	NO	20	18,69 €
000661	G	Ø98X26	Ø70	REDONDO	NO	20	21,30 €

NC1760 CUADRADO

REF.	ACABADO	DIMENSIONES (mm)	ØCUT (mm)	FORMATO	OSCILANTE	IP	P.V.P.
000685	CH	98X98X26	Ø70	CUADRADO	NO	20	29,27 €
000678	W	98X98X26	Ø70	CUADRADO	NO	20	26,51 €

ACCESORIOS/ACCESSORIES

REF.	DESCRIPCIÓN	P.V.P.
032730	ACCESORIO PANEL DE ABEJA	1,10 €

SERIE NC1765



DIMENSIONES DIMENSIONS

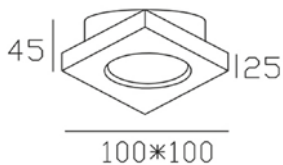
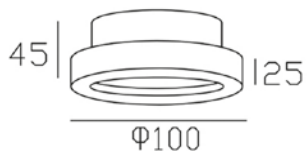

ACABADOS FINISHES



ACCESORIOS ACCESSORIES

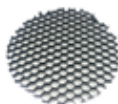

Accesorio
Panel Abeja

NC1765 REDONDO

REF.	ACABADO	DIMENSIONES (mm)	ØCUT (mm)	FORMATO	OSCILANTE	IP	P.V.P.
010288	A	Ø100X45	Ø65	REDONDO	NO	20	27,53 €
010301	BK	Ø100X45	Ø65	REDONDO	NO	20	30,00 €
010295	F	Ø100X45	Ø65	REDONDO	NO	20	30,42 €

NC1765 CUADRADO

REF.	ACABADO	DIMENSIONES (mm)	ØCUT (mm)	FORMATO	OSCILANTE	IP	P.V.P.
010257	A	100X100X45	Ø65	CUADRADO	NO	20	26,65 €
010271	BK	100X100X45	Ø65	CUADRADO	NO	20	29,13 €
010264	F	100X100X45	Ø65	CUADRADO	NO	20	29,55 €

ACCESORIOS/ACCESSORIES

REF.	DESCRIPCIÓN	P.V.P.
032730	ACCESORIO PANEL DE ABEJA	1,10 €

SERIE NC1825-M



DIMENSIONES DIMENSIONS

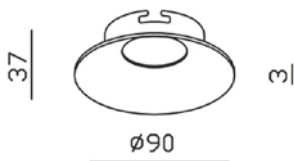

ACABADOS FINISHES



ACCESORIOS ACCESSORIES

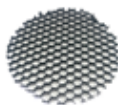

Accesorio
Panel Abeja

NC1825-M REDONDO

REF.	ACABADO	DIMENSIONES (mm)	ØCUT (mm)	FORMATO	OSCILANTE	IP	P.V.P.
017614	BK	Ø90X37	Ø75	REDONDO	NO	20	15,37 €
000715	CH	Ø90X37	Ø75	REDONDO	NO	20	15,37 €
000708	W	Ø90X37	Ø75	REDONDO	NO	20	13,19 €

NC1825-M REDONDO IP54

REF.	ACABADO	DIMENSIONES (mm)	ØCUT (mm)	FORMATO	OSCILANTE	IP	P.V.P.
005413	BK	Ø90X37	Ø75	REDONDO	NO	20	17,72 €
005505	CH	Ø90X37	Ø75	REDONDO	NO	20	17,72 €
005598	W	Ø90X37	Ø75	REDONDO	NO	20	15,54 €

ACCESORIOS/ACCESSORIES

REF.	DESCRIPCIÓN	P.V.P.
032730	ACCESORIO PANEL DE ABEJA	1,10 €

7.3.

AROS DE ALUMINIO
ECO PLUS
ECO PLUS
ALUMINIUM RINGS

SERIE NC3014



Al

IP 20
RATED



800 mm

80°

GU10

50 unid.

RoHS
COMPLIANT

CE

GU10 INCLUDED

DIMENSIONES DIMENSIONS

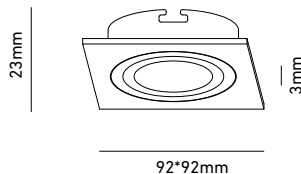
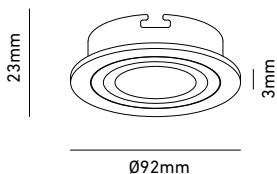

ACABADOS FINISHES



ACCESORIOS ACCESSORIES

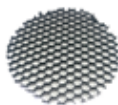

Accesorio
Panel Abeja

NC3014 REDONDO ORIENTABLE

REF.	ACABADO	DIMENSIONES (mm)	ØCUT (mm)	FORMATO	OSCILANTE	IP	P.V.P.
035656	W	Ø92X23	Ø80	REDONDO	SI	20	6,45 €
035663	FBK	Ø92X23	Ø80	REDONDO	SI	20	6,45 €
035670	BU	Ø92X23	Ø80	REDONDO	SI	20	6,89 €

NC3014 CUADRADO ORIENTABLE

REF.	ACABADO	DIMENSIONES (mm)	ØCUT (mm)	FORMATO	OSCILANTE	IP	P.V.P.
035687	W	92X92X23	Ø80	CUADRADO	SI	20	6,89 €
035694	FBK	92X92X23	Ø80	CUADRADO	SI	20	6,89 €
035700	BU	92X92X23	Ø80	CUADRADO	SI	20	7,44 €

ACCESORIOS/ACCESSORIES

REF.	DESCRIPCIÓN	P.V.P.
032730	ACCESORIO PANEL DE ABEJA	1,10 €

SERIE NC1301



AL

IP 20
RATED



865 mm

GU10

50 unid.

RoHS
COMPLIANT

CE

GU10 INCLUDED

DIMENSIONES DIMENSIONS

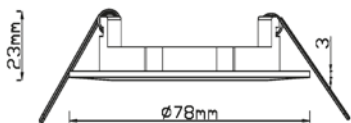

ACABADOS FINISHES

FW

GY

FBK

CH

SN

NC1301 REDONDO FIJO

REF.	ACABADO	DIMENSIONES (mm)	ØCUT (mm)	FORMATO	OSCILANTE	IP	P.V.P.
028870	FW	Ø78X23	Ø65	REDONDO	SI	20	3,23 €
028917	GY	Ø78X23	Ø65	REDONDO	SI	20	3,77 €
028887	FBK	Ø78X23	Ø65	REDONDO	SI	20	3,23 €
028894	CH	Ø78X23	Ø65	REDONDO	SI	20	3,77 €
028900	SN	Ø78X23	Ø65	REDONDO	SI	20	3,77 €

SERIE NC1302



Al

IP 20
RATED



Ø75 mm

80°

GU10

50 unid.

RoHS
COMPLIANT

CE

GU10 INCLUDED

DIMENSIONES DIMENSIONS

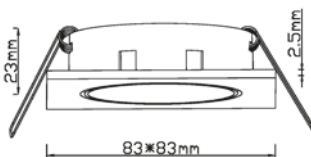
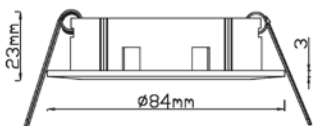

ACABADOS FINISHES



NC1302 REDONDO ORIENTABLE

REF.	ACABADO	DIMENSIONES (mm)	ØCUT (mm)	FORMATO	OSCILANTE	IP	P.V.P.
028924	FW	84X23	Ø75	REDONDO	SI	20	4,04 €
028931	FBK	84X23	Ø75	REDONDO	SI	20	4,04 €
028948	CH	84X23	Ø75	REDONDO	SI	20	4,85 €
028955	SN	84X23	Ø75	REDONDO	SI	20	4,85 €
028962	GY	84X23	Ø75	REDONDO	SI	20	4,85 €

NCC1302 CUADRADO ORIENTABLE

REF.	ACABADO	DIMENSIONES (mm)	ØCUT (mm)	FORMATO	OSCILANTE	IP	P.V.P.
028979	FW	83X83X23	Ø75	CUADRADO	SI	20	4,45 €
028986	GY	83X83X23	Ø75	CUADRADO	SI	20	4,99 €

8.

PLAFONES
CEILING LIGHTS

PLAFONES LED PC CCT IP54



SELECTOR CCT

Sistema para elegir la temperatura de color mediante interruptor. Permite seleccionar entre blanco cálido (3000K), neutro (4000K) y frío (5700K).



SELECTOR DE POTENCIA

Sistema de selección de la potencia mediante un interruptor. Posibilidad de seleccionar la potencia deseada entre 14w, 18w y 22w.



50.000h



AC
220V
240V



IP 54
RATED



Hz
50/60



CRI
>80



IK08



PF
>0.7



120°



-15°+40°



CCT
3000/4000K
5700K



POW SELEC.
14W/18W/22W



RoHS
COMPLIANT



CE



3 AÑOS
GARANTÍA

DIMENSIONES DIMENSIONS

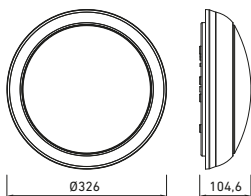

FOTOMETRÍA PHOTOMETRY

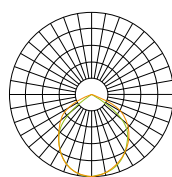

ACABADOS FINISHES



REF.	POW.	ACABADO	CCT	LM	ANG.	CRI	IP	P.V.P.
037520	14W	BLANCO	3000K	1400LM	120°	>80	54	34,00 €
	18W		4000K	1800LM				
	22W		5700K	2200LM				

PLAFONES LED PC IP54 XL



DIMENSIONES DIMENSIONS

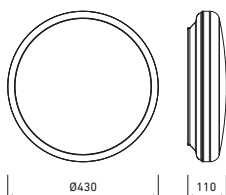

FOTOMETRÍA PHOTOMETRY

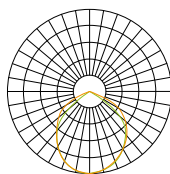

ACABADOS FINISHES



REF.	POW.	ACABADO	CCT	LM	ANG.	CRI	IP	P.V.P.
037537	32W	BLANCO	4000K	3200LM	120°	>80	54	44,80 €
037544	32W	BLANCO	5700K	3200LM	120°	>80	54	44,80 €

PLAFONES LED ECO CCT IP65



SELECTOR CCT

Sistema para elegir la temperatura de color mediante interruptor. Permite seleccionar entre blanco cálido (3000K), neutro (4000K) y frío (5700K).



SELECTOR DE POTENCIA

Sistema de selección de la potencia mediante un interruptor. Posibilidad de seleccionar la potencia deseada entre 9w, 11w y 16w.

PC

1.100
1.500
2.000
LUMEN

50.000h

AC
220V
240V

IP65
RATED

CRI
>80

IK08

PF
>0.5

120°

CCT
3000/4000/5700K

POW SELEC.
9W/11W/16W

-15°+40°

RoHS
COMPLIANT

CE

5 AÑOS
GARANTIA

DIMENSIONES DIMENSIONS

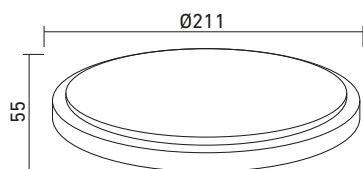

FOTOMETRÍA PHOTOMETRY

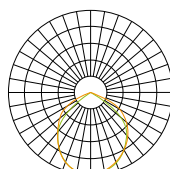

ACABADOS FINISHES



REF.	POW.	ACABADO	CCT	LM	ANG.	CRI	IP	P.V.P.
038404	9W	BLANCO	3000K	1100LM	120°	>80	65	23,50 €
	12W	NEGRO	4000K	1500LM				
	16W		5700K	2000LM				

PLAFONES LED ECO CCT IP65



SELECTOR CCT

Sistema para elegir la temperatura de color mediante interruptor. Permite seleccionar entre blanco cálido (3000K), neutro (4000K) y frío (5700K).



SELECTOR DE POTENCIA

Sistema de selección de la potencia mediante un interruptor. Posibilidad de seleccionar la potencia deseada entre 9w, 11w y 16w.

PC

1.100
1.500
2.000
LUMEN

50.000h

AC
220V
240V

IP65
RATED

CRI
>80

IK08

PF
>0.5

120°

CCT
3000/4000/5700K

POW SELEC.
9W/11W/16W

-15°+40°

RoHS
COMPLIANT

CE

5 AÑOS
GARANTIA

DIMENSIONES DIMENSIONS

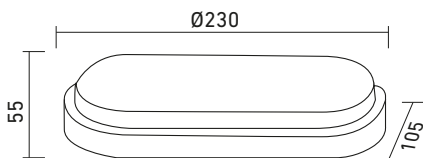

FOTOMETRÍA PHOTOMETRY

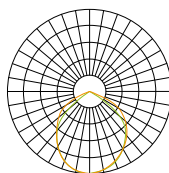

ACABADOS FINISHES



REF.	POW.	ACABADO	CCT	LM	ANG.	CRI	IP	P.V.P.
038374	9W	BLANCO	3000K	1100LM	120°	>80	65	21,00 €
	12W	NEGRO	4000K	1500LM				
	16W		5700K	2000LM				

PLAFONES LED CCT IP65



SELECTOR CCT

Sistema para elegir la temperatura de color mediante interruptor. Permite seleccionar entre blanco cálido (3000K), neutro (4000K) y frío (5700K).



SELECTOR DE POTENCIA

Sistema de selección de la potencia mediante un interruptor. Posibilidad de seleccionar la potencia deseada entre 9w, 14w y 18w.



50.000h



AC 220V 240V



IP65 RATED



Hz 50/60



CRI >80



IK08



PF >0.7



120°



CCT 3000/4000K/5700K



POW SELEC. 9W/14W/18W



-15°+40°



RoHS COMPLIANT



CE



3 AÑOS GARANTÍA

DIMENSIONES DIMENSIONS

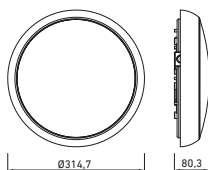

FOTOMETRÍA PHOTOMETRY

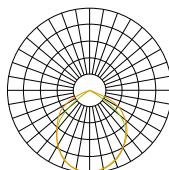

ACABADOS FINISHES



ACCESORIOS ACCESSORIES



REF.	POW.	ACABADO	CCT	LM	ANG.	CRI	IP	P.V.P.
037551	9W	BLANCO	3000K	900LM	120°	>80	65	26,40 €
	14W		4000K	1400LM				
	18W		5700K	1800LM				
037841	9W	NEGRO	3000K	900LM	120°	>80	65	26,40 €
	14W		4000K	1400LM				
	18W		5700K	1800LM				
037858	9W	BLANCO MEDIA LUNA	3000K	600LM	120°	>80	65	26,40 €
	14W		4000K	980LM				
	18W		5700K	1260LM				
037865	9W	NEGRO MEDIA LUNA	3000K	600LM	120°	>80	65	26,40 €
	14W		4000K	980LM				
	18W		5700K	1260LM				

ACCESORIOS/ACCESSORIES

REF.	DESCRIPCIÓN	P.V.P.
037605	ACCESORIO CARCASA CIRCULAR BLANCO	3,60 €
037612	ACCESORIO CARCASA CIRCULAR NEGRO	3,60 €
037629	ACCESORIO CARCASA MEDIA LUNA BLANCO	3,60 €
037636	ACCESORIO CARCASA MEDIA LUNA NEGRO	3,60 €

APLIQUE LED CUADRADO IP65



SELECTOR CCT

Sistema para elegir la temperatura de color mediante interruptor. Permite seleccionar entre blanco cálido (3000K), neutro (4000K) y frío (5700K).



SELECTOR DE POTENCIA

Sistema de selección de la potencia mediante un interruptor. Posibilidad de seleccionar la potencia deseada entre 9w, 12w y 15w.



50.000h



AC 220V 240V



IP65 RATED



Hz 50/60



CRI >80



IK08



PF >0.7



120°



-15°+45°



CCT 3000K/4000K 5700K



POW SELEC. 9W/12W/15W



RoHS COMPLIANT



CE



3 AÑOS GARANTÍA

DIMENSIONES DIMENSIONS

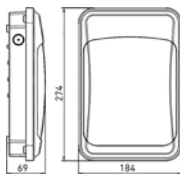

FOTOMETRÍA PHOTOMETRY

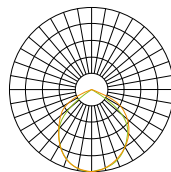

ACABADOS FINISHES



REF.	POW.	ACABADO	CCT	LM	ANG.	CRI	IP	P.V.P.
037582	9W	BLANCO	3000K	900LM	120°	>80	65	23,60 €
	12W		4000K	1200LM				
	15W		5700K	1500LM				
037599	9W	NEGRO	3000K	900LM	120°	>80	65	23,60 €
	12W		4000K	1200LM				
	15W		5700K	1500LM				

APLIQUE LED ALUMINIO IP65



AL 50.000h **AC** 220V 240V **IP65** RATED **Hz** 50/60 **CRI** >80 **IK08** **PF** >0.7 **120°** -15°+45° **RoHS** COMPLIANT **CE** **3 AÑOS** GARANTÍA

DIMENSIONES DIMENSIONS

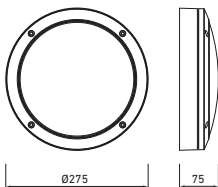

FOTOMETRÍA PHOTOMETRY

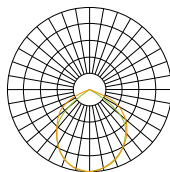

ACABADOS FINISHES



REF.	POW.	ACABADO	CCT	LM	ANG.	CRI	IP	P.V.P.
037568	18W	NEGRO	4000K	1600LM	120°	>80	65	82,00 €
037575	18W	NEGRO MEDIA LUNA	4000K	1400LM	120°	>80	65	84,00 €

PLAFONES LED PC SENSOR E27X2



IP 20
RATED

MATERIAL
PC

CE

RoHS
COMPLIANT

DIMENSIONES DIMENSIONS

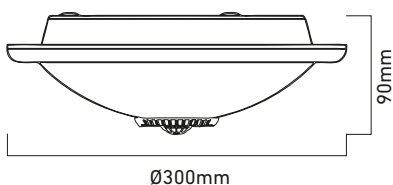

FOTOMETRÍA PHOTOMETRY

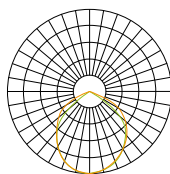

ACABADOS FINISHES



REF.	POW.	ACABADO	CCT	LM	ANG.	CRI	IP	P.V.P.
058009	-	BLANCO	-	-	120°	-	20	22,20 €

9.

APLIQUES
WALL LIGHTS

SERIES LC452 - EMPOTRABLE



3.000°K **Al** **250 LUMEN** **3W** **AC 220V 240V** **50.000h** **24°** **Hz 50/60** **PF >0.9** **IP 20 RATED** **CRI >90** **NO DIMMABLE**

RoHS COMPLIANT **CE** **CREE** **EAGLE RISE**

DIMENSIONES DIMENSIONS

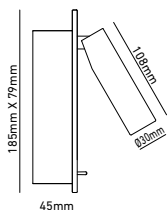

FOTOMETRÍA PHOTOMETRY

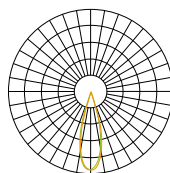

ACABADOS FINISHES



REF.	POW.	ACABADO	CCT	LM	ANG.	CRI	ØCUT (mm)	P.V.P.
038435	3W	FW	3000K	250	24°	90	16,5X5,5	57,66 €
038442	3W	FBK	3000K	250	24°	90	16,5X5,5	57,66 €

SERIES LC447 - SUPERFICIE



3.000°K **Al** **300 +700 LUMEN** **3W +7W** **AC 220V 240V** **50.000h** **24°** **Hz 50/60** **PF >0.9** **IP 20 RATED** **CRI >90** **NO DIMMABLE**
RoHS COMPLIANT **CE** **EAGLE RISE**

DIMENSIONES DIMENSIONS

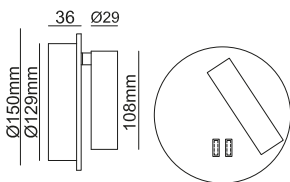

FOTOMETRÍA PHOTOMETRY

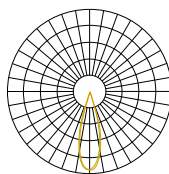

ACABADOS FINISHES



REF.	POW.	ACABADO	CCT	LM	ANG.	CRI	IP	P.V.P.
038947	3W+7W	FW	3000K	300+700	24°	90	IP20	64,72 €
038954	3W+7W	FBK	3000K	300+700	24°	90	IP20	64,72 €

SERIES LC454 - SUPERFICIE



3.000°K **Al** **300 +700 LUMEN** **3W +7W** **AC 220V 240V** **50.000h** **24°** **Hz 50/60** **PF >0.9** **IP 20 RATED** **CRI >90** **NO DIMMABLE**

RoHS COMPLIANT **CE** **EAGLE RISE**

DIMENSIONES DIMENSIONS

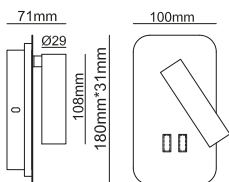

FOTOMETRÍA PHOTOMETRY

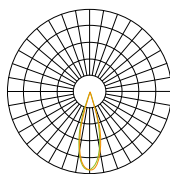

ACABADOS FINISHES



REF.	POW.	ACABADO	CCT	LM	ANG.	CRI	ØCUT (mm)	P.V.P.
038961	3W+7W	FW	3000K	300+700	24°	90	IP20	62,55 €
038978	3W+7W	FBK	3000K	300+700	24°	90	IP20	62,55 €

SERIES LC073

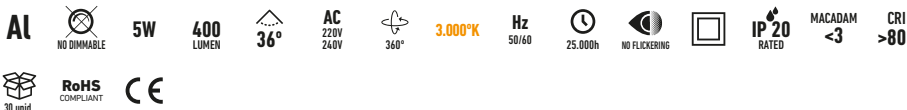

DIMENSIONES DIMENSIONS

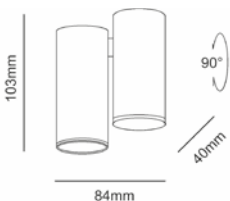

FOTOMETRÍA PHOTOMETRY

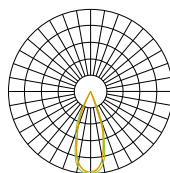

ACABADOS FINISHES



REF.	POW.	ACABADO	CCT	LM	ANG.	CRI	IP	P.V.P.
027903	5W	FW	3000K	400	36°	80	20	39,73 €
027910	5W	FBK	3000K	400	36°	80	20	39,73 €

10.

TIRAS LED
LED STRIPS

LED MONOCOLOR 2835 TOP SERIES - 4,8W - IP20

DC 24V 4,8W IP 20 RATED CRI >80 SMD2835 8MM 60 5M/REEL RoHS COMPLIANT CE

Corte mínimo cada 100mm (6 LEDs)

REF	CCT	Lm/W	ANG	POW	IP	VOLT	LxW(mm)	P.V.P.
032181	27K	87,36	180°	4,8W	IP20	DC24V	5000x8	23,10 €
036059	30K	87,36	180°	4,8W	IP20	DC24V	5000x8	23,10 €

LED MONOCOLOR 2835 TOP SERIES - 4,8W - IP65

DC 24V 4,8W IP 65 RATED CRI >80 SMD2835 8MM 60 5M/REEL RoHS COMPLIANT CE

Corte mínimo cada 100mm (6 LEDs)

REF	CCT	Lm/W	ANG	POW	IP	VOLT	LxW(mm)	P.V.P.
032198	27K	87,36	180°	4,8W	IP65	DC24V	5000x8	39,50 €

LED MONOCOLOR 2835 TOP SERIES - 9,6W - IP20

DC 24V 9,6W IP 20 RATED CRI >80 SMD2835 8MM 120 5M/REEL RoHS COMPLIANT CE

Corte mínimo cada 50mm (6 LEDs)

REF	CCT	Lm/W	ANG	POW	IP	VOLT	LxW(mm)	P.V.P.
031245	27K	100	180°	9,6W	IP20	DC24V	5000x8	26,02 €
031252	30K	100	180°	9,6W	IP20	DC24V	5000x8	26,02 €
031269	40K	100	180°	9,6W	IP20	DC24V	5000x8	26,02 €
031276	60K	100	180°	9,6W	IP20	DC24V	5000x8	26,02 €

LED MONOCOLOR 2835 TOP SERIES - 9,6W - IP65

DC 24V 9,6W IP65 RATED CRI >80 SMD2835 8MM 120 5M/REEL RoHS COMPLIANT CE

Corte mínimo cada 50mm (6 LEDs)

REF	CCT	Lm/W	ANG	POW	IP	VOLT	LxW(mm)	P.V.P.
032204	27K	100	180°	9,6W	IP65	DC24V	5000x8	41,58 €
035731	30K	100	180°	9,6W	IP65	DC24V	5000x8	41,58 €
032211	40K	100	180°	9,6W	IP65	DC24V	5000x8	41,58 €
035748	60K	100	180°	9,6W	IP65	DC24V	5000x8	41,58 €

LED MONOCOLOR 2835 TOP SERIES - 14,4W - IP20

DC 24V 14,4W IP20 RATED CRI >80 SMD2835 8MM 120 5M/REEL RoHS COMPLIANT CE

Corte mínimo cada 50mm (6 LEDs)

REF	CCT	Lm/W	ANG	POW	IP	VOLT	LxW(mm)	P.V.P.
032228	23K	100	180°	14,4W	IP20	DC24V	5000x8	30,35 €
031283	27K	100	180°	14,4W	IP20	DC24V	5000x8	28,35 €
031290	30K	100	180°	14,4W	IP20	DC24V	5000x8	28,35 €
031306	40K	100	180°	14,4W	IP20	DC24V	5000x8	28,35 €
031313	60K	100	180°	14,4W	IP20	DC24V	5000x8	28,35 €

LED MONOCOLOR 2835 TOP SERIES - 14,4W - IP65

DC 24V 14,4W IP65 RATED CRI >80 SMD2835 8MM 120 5M/REEL RoHS COMPLIANT CE

Corte mínimo cada 50mm (6 LEDs)

REF	CCT	Lm/W	ANG	POW	IP	VOLT	LxW(mm)	P.V.P.
031474	27K	100	180°	14,4W	IP65	DC24V	5000x8	41,58 €
031481	30K	100	180°	14,4W	IP65	DC24V	5000x8	41,58 €
031498	40K	100	180°	14,4W	IP65	DC24V	5000x8	41,58 €
031504	60K	100	180°	14,4W	IP65	DC24V	5000x8	41,58 €

LED MONOCOLOR 2835 TOP SERIES - 19,2W - IP20

DC 24V 19,2W IP20 RATED CRI >80 SMD2835 10MM 240 5M/REEL RoHS COMPLIANT CE

Corte mínimo cada 33mm (6 LEDs)

REF	CCT	Lm/W	ANG	POW	IP	VOLT	LxW(mm)	P.V.P.
031320	27K	118.51	180°	19,2W	IP20	DC24V	5000x10	52,04 €
031337	30K	118.51	180°	19,2W	IP20	DC24V	5000x10	52,04 €
031344	40K	124.44	180°	19,2W	IP20	DC24V	5000x10	52,04 €
031351	60K	124.44	180°	19,2W	IP20	DC24V	5000x10	52,04 €

LED MONOCOLOR 2835 TOP SERIES - 19,2W - IP65

DC 24V 19,2W IP65 RATED CRI >80 SMD2835 10MM 240 5M/REEL RoHS COMPLIANT CE

Corte mínimo cada 33mm (6 LEDs)

REF	CCT	Lm/W	ANG	POW	IP	VOLT	LxW(mm)	P.V.P.
031511	27K	118.51	180°	19,2W	IP65	DC24V	5000x10	68,15 €
031528	30K	118.51	180°	19,2W	IP65	DC24V	5000x10	68,15 €
031535	40K	124.44	180°	19,2W	IP65	DC24V	5000x10	68,15 €
031542	60K	124.44	180°	19,2W	IP65	DC24V	5000x10	68,15 €

LED MONOCOLOR HIGH PERFORMANCE -11W - IP20

DC 24V 11W IP20 RATED CRI >90 SMD2835 10MM 160 5M/REEL RoHS COMPLIANT CE

Corte mínimo cada 50mm (6 LEDs)

REF	CCT	Lm/W	ANG	POW	IP	VOLT	LxW(mm)	P.V.P.
039265	2700K	136,36	180°	11W	IP20	DC24V	5000x10	20,63 €
039272	3000K	136,36	180°	11W	IP20	DC24V	5000x10	20,63 €
039289	4000K	136,36	180°	11W	IP20	DC24V	5000x10	20,63 €
039296	5700K	136,36	180°	11W	IP20	DC24V	5000x10	20,63 €

LED RGB SERIES - RGB+WHITE 22W - IP20

DC 24V 22W IP 20 RATED CRI - SMD5050 12MM 96 5M/REEL RoHS COMPLIANT CE

Corte mínimo cada 83mm (6 LEDs)

REF	CCT	Lm/W	ANG	POW	IP	VOLT	LxW(mm)	P.V.P.
031467	RGB+W 40K	38.28	180°	22W	IP20	DC24V	5000X12	62,07 €

LED RGB SERIES - RGB+WW+CW - 20W - IP20

DC 24V 20W IP 20 RATED CRI - SMD2835 12MM 210 5M/REEL RoHS COMPLIANT CE

Corte mínimo cada 100mm (21 LEDs)

REF	CCT	Lm/W	ANG	POW	IP	VOLT	LxW(mm)	P.V.P.
031368	RGB +WW27K- CW60K	83.1	180°	20W	IP20	DC24V	5000X12	85,98 €

LED CCT SERIES - 21W - IP20

DC 24V 21W IP 20 RATED CRI >80 SMD2835 12MM 224 5M/REEL RoHS COMPLIANT CE

Corte mínimo cada 71mm (16 LEDs)

REF	CCT	Lm/W	ANG	POW	IP	VOLT	LxW(mm)	P.V.P.
031375	27K-65K	130	180°	21W	IP20	DC24V	5000X12	56,00 €

LED COB SERIES - 5W - IP20

DC 24V 10W IP20 RATED CRI >90 SMD2016 4MM 384 5M/REEL RoHS COMPLIANT CE

Corte mínimo cada 41,6mm (32 LEDs)

REF	CCT	Lm/W	ANG	POW	IP	VOLT	LxW(mm)	P.V.P.
039180	2700K	90	180°	5W	IP20	DC24V	5000x4	26,84 €
039197	3000K	90	180°	5W	IP20	DC24V	5000x4	26,84 €
039203	4000K	90	180°	5W	IP20	DC24V	5000x4	26,84 €
039210	5700K	90	180°	5W	IP20	DC24V	5000x4	26,84 €



LED COB SERIES - 10W - IP20

DC 24V 10W IP20 RATED CRI >90 SMD2016 10MM 512 5M/REEL RoHS COMPLIANT CE

Corte mínimo cada 62mm (32 LEDs)

REF	CCT	Lm/W	ANG	POW	IP	VOLT	LxW(mm)	P.V.P.
031382	27K	110	180°	10W	IP20	DC24V	5000x10	46,90 €
031399	30K	110	180°	10W	IP20	DC24V	5000x10	46,90 €
031405	40K	110	180°	10W	IP20	DC24V	5000x10	46,90 €
031412	60K	110	180°	10W	IP20	DC24V	5000x10	46,90 €



LED COB SERIES - 11W - IP20

DC 24V 11W IP20 RATED CRI >90 SMD2016 8MM 512 5M/REEL RoHS COMPLIANT CE

Corte mínimo cada 31mm (32 LEDs)

REF	CCT	Lm/W	ANG	POW	IP	VOLT	LxW(mm)	P.V.P.
039227	2700K	86	180°	11W	IP20	DC24V	5000x8	28,90 €
039234	3000K	86	180°	11W	IP20	DC24V	5000x8	28,90 €
039241	4000K	86	180°	11W	IP20	DC24V	5000x8	28,90 €
039258	5700K	86	180°	11W	IP20	DC24V	5000x8	28,90 €



LED COB SERIES - 18W - IP20

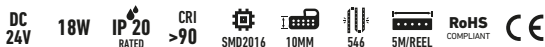

Corte mínimo cada 38mm (21 LEDs)

REF	CCT	Lm/W	ANG	POW	IP	VOLT	LxW(mm)	P.V.P.
031429	27K	110	180°	18W	IP20	DC24V	5000x10	77,00 €
031436	30K	110	180°	18W	IP20	DC24V	5000x10	77,00 €
031443	40K	110	180°	18W	IP20	DC24V	5000x10	77,00 €
031450	60K	110	180°	18W	IP20	DC24V	5000x10	77,00 €



LED DOA 220V SERIES - 8W - IP65



Corte mínimo cada 100mm (32 LEDs)

REF	CCT	Lm/W	ANG	POW	IP	VOLT	LxW(mm)	P.V.P.
039142	2700K	90	180°	8W	IP65	AC220V	50000x8	145,31 €
039159	3000K	90	180°	8W	IP65	AC220V	50000x8	145,31 €
039166	4000K	90	180°	8W	IP65	AC220V	50000x8	145,31 €
039173	5700K	90	180°	8W	IP65	AC220V	50000x8	145,31 €

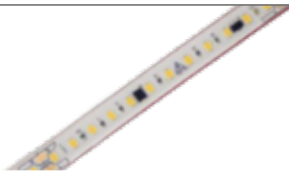

ACCESORIOS TIRAS DE LED LED STRIPS ACCESSORIES

REF.	DESCRIPCIÓN	P.V.P.
039763	ACC. CONECTOR INTERMEDIO PARA TIRAS LED SMD2835 -160P 10MM	1,78 €
039764	ACC. CONECTOR INTERMEDIO PARA TIRAS LED COB-512 8MM	1,78 €
039765	ACC. CLIP DE FIJACIÓN PARA TIRAS DE 10MM	0,23 €
039766	ACC. CLIP DE FIJACIÓN PARA TIRAS DE 8MM	0,23 €
039767	ACC. CABLE ROJO Y NEGRO PARA TIRA MONOCOLOR 10MM	0,63 €
039768	ACC. CABLE ROJO Y NEGRO PARA TIRA MONOCOLOR 4MM	0,63 €
039769	ACC. CABLE ROJO Y NEGRO PARA TIRA MONOCOLOR 8MM	0,63 €
039770	ACC. CONECTOR PARA TIRAS LED DOA	4,38 €
039771	TAPA FINAL PARA TIRA DE LED DOA 8W AC220V	0,09 €
039772	CLIP FIJACIÓN PARA TIRA DE LED DOA 8W AC220v (cada clip requiere tornillo)	0,22 €

11.

**FUENTES DE
ALIMENTACIÓN**
POWER SUPPLY

FUENTE DE ALIMENTACIÓN 24V KGP COMPACT IP20

IP 20
RATED

RoHS
COMPLIANT



3 AÑOS
GARANTÍA



REF	POW	AH (AMPERIOS)	MEDIDAS (LXWXH)	P.V.P.
037643	30W	1,25	135X36X25mm	16,50 €
037650	60W	2,5	151.5X40.2X31mm	23,00 €
037667	120W	5	253X42.5X31mm	44,50 €
037674	180W	7,5	253X42.5X31mm	54,00 €

FUENTE DE ALIMENTACIÓN 24V KGP COMPACT IP67

IP 67
RATED

RoHS
COMPLIANT



3 AÑOS
GARANTÍA



REF	POW	AH (AMPERIOS)	MEDIDAS (LXWXH)	P.V.P.
037681	36W	1,5	148X40X30mm	22,75 €
037698	60W	2,5	166X42X34mm	33,75 €
037704	100W	4,17	190X52X37mm	48,50 €

FUENTE DE ALIMENTACIÓN 24V KGP COMPACT IP67

IP 67
RATED

RoHS
COMPLIANT



3 AÑOS
GARANTÍA



REF	POW	AH (AMPERIOS)	MEDIDAS (LXWXH)	P.V.P.
037711	150W	6,3	215X53X31.5mm	70,75 €

FUENTE DE ALIMENTACIÓN 24V YLD IP20

IP 20
RATED

RoHS
COMPLIANT



3 AÑOS
GARANTÍA



REF	POW	AH (AMPERIOS)	MEDIDAS (LXWXH)	P.V.P.
039302	36W	1,5	146X47,4X29,3 mm	9,72 €
037773	60W	2,5	146X47.4X29.3mm	11,88 €
037780	100W	4,1	177X47.1X31.5mm	14,44 €
037797	200W	8,3	187X57.1X31.7mm	22,78 €
037803	300W	12,5	228X59.8X31.7mm	30,39 €
037810	400W	16,5	228X59.8X31.7mm	39,46 €

FUENTE DE ALIMENTACIÓN 24V INFINITUM REGULABLES TRIAC IP20

IP 20
RATED

RoHS
COMPLIANT



3 AÑOS
GARANTÍA



REF	POW	AH (AMPERIOS)	MEDIDAS (LXWXH)	P.V.P.
039773	30	1,25	155 x 54 x 20mm	62,26 €
039774	60	2,5	178 x 61 x 24mm	100,10 €
039775	100	4,17	330 x 30 x 22mm	150,00 €
039776	150	6,25	368 x 30 x 22,5mm	193,00 €
039778	200	8,3	278 x 78 x 47mm	224,60 €

FUENTE DE ALIMENTACIÓN 24V MEANWELL REGULABLES 0-10V IP67

IP 67
RATED

RoHS
COMPLIANT



3 AÑOS
GARANTÍA



REF	POW	AH (AMPERIOS)	MEDIDAS (LXWXH)	P.V.P.
039779	40	1,67	150*53*35mm	66,73 €
039780	60	2,5	141.5*49*32mm	68,00 €
039781	120	5	191*63*37.5mm	110,33 €
039782	200	8,3	195*68*39.5mm	133,86 €

FUENTE DE ALIMENTACIÓN 24V EAGLERISE REGULABLES DALI/PUSH IP20

IP 20
RATED

RoHS
COMPLIANT

CE

3 AÑOS
GARANTÍA



DT6

REF	POW	AH (AMPERIOS)	MEDIDAS (LXWXH)	P.V.P.
039783	30	1,25	280 x 30 x 21mm	32,80 €
039785	45	1,88	168 x 38 x 30mm	39,23 €
039786	60	2,5	360 x 30 x 21mm	49,56 €
039787	80	3,33	227 x 38 x 30mm	52,83 €
039788	100	4,17	425 x 21 x 30mm	58,06 €
039789	150	6,25	318 x 38 x 30mm	71,33 €
039790	250	10,41	431 x 45 x 30,5mm	84,76 €

FUENTE DE ALIMENTACIÓN 24V EAGLERISE REGULABLES DALI/PUSH IP20

IP 20
RATED

RoHS
COMPLIANT

CE

3 AÑOS
GARANTÍA



DT8

REF	POW	AH (AMPERIOS)	MEDIDAS (LXWXH)	P.V.P.
039792	45	1,87	187 x 45 x 30,5mm	41,16 €
039793	80	3,3	340 x 45 x 30,5mm	53,13 €
039794	150	6,25	340 x 45 x 30,5mm	82,40 €

12.

CONTROLADORES
LED CONTROLLER

CONTROLADORES



REF.	DESCRIPCIÓN	P.V.P
039757	CONTROLADOR RF 2,4 GHZ MONOCOLOR-CCT	25,00 €
039111	CONTROLADOR RF 2,4 GHZ RGB-RGBW-RGB+CCT	25,00 €
003758	CONTROLADOR RF 2,4 GHZ MONOCOLOR-CCT + WIFI TUYA	45,00 €
039759	CONTROLADOR RF 2,4 GHZ RGB-RGBW-RGB+CCT + WIFI TUYA	45,00 €

MANDOS DE TIRA LED



REF.	DESCRIPCIÓN	P.V.P
039756	MANDO 4 ZONAS RF 2,4 GHZ MONOCOLOR-CCT	30,00 €
039104	MANDO 4 ZONAS RF 2,4 GHZ RGB-RGBW-RGB+CCT	30,00 €
039333	MANDO 8 ZONAS RF 2,4 GHZ RGB-RGBW-RGB+CCT	41,66 €

13.

**PERFILERÍA
DE ALUMINIO**
PROFILE
ALUMINUM

PERFILES RODAPIÉ

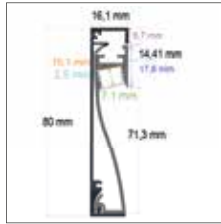

PERFIL PARA RODAPIÉ O PARED

Referencia	Medidas	P.V.P.
PL8016	80x16,1 mm. x 2 m.	94,28 €
PL80161	BLANCO - 80x16,1 mm. x 2 m.	99,24 €

Incluye difusor opal y 2 tapas
Perfil de aluminio y difusor de PC

RoHS 10 Uds.



PERFIL PARA RODAPIÉ O PARED

Referencia	Medidas	P.V.P.
PL7014	70x14,4 mm. x 2 m.	39,70 €

Incluye difusor opal y 2 tapas
Perfil de aluminio y difusor de PC

RoHS 40 Uds.



PERFILES ESQUINA

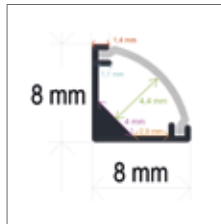

PERFIL EXTRAFINO DE ESQUINA CON EL DIFUSOR CURVO

Referencia	Medidas	P.V.P.
PL881	8x8 mm. x 2 m.	8,47 €

Incluye difusor opal, 2 tapas y 4 grapas
Perfil de aluminio y difusor de PC

RoHS | 300 Uds.

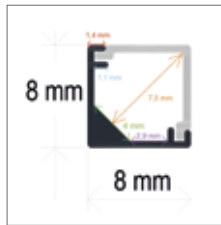

PERFIL EXTRAFINO DE ESQUINA CON EL DIFUSOR EN ÁNGULO RECTO

Referencia	Medidas	P.V.P.
PL882	8x8 mm. x 2 m.	8,73 €

Incluye difusor opal, 2 tapas y 4 grapas
Perfil de aluminio y difusor de PC

RoHS | 300 Uds.

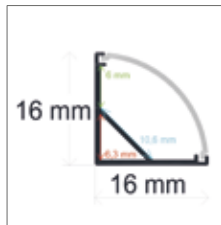

PERFIL DE ESQUINA CON EL DIFUSOR CURVO

Referencia	Medidas	P.V.P.
PL1615	16x16 mm. x 2 m.	9,82 €
PL16151	BLANCO - 16x16 mm. x 2 m.	10,57 €
PL16152	NEGRO - 16x16 mm. x 2 m.	10,57 €

Incluye difusor opal, 2 tapas y 4 grapas.
Perfil de aluminio y difusor de PC. Accesorio: PL5014

RoHS | 100 Uds.

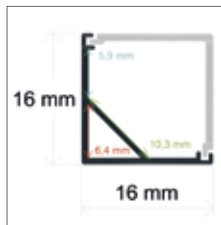

PERFIL DE ESQUINA CON EL DIFUSOR EN ÁNGULO RECTO

Referencia	Medidas	P.V.P.
PL1616	16x16 mm. x 2 m.	11,81 €

Incluye difusor opal, 2 tapas y 4 grapas
Perfil de aluminio y difusor de PC

RoHS | 100 Uds.

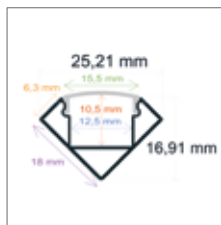

PERFIL DE ESQUINA REFORZADO Y CON EMBELLECEDORES

Referencia	Medidas	P.V.P.
PL1818	25,21x16,91 mm. x 2 m.	15,05 €
PL18181	BLANCO - 25,21x16,91 mm. x 2 m.	16,13 €
PL18182	NEGRO - 25,21x16,91 mm. x 2 m.	16,13 €

Incluye difusor opal, 2 tapas y 4 grapas
Perfil de aluminio y difusor de PC

RoHS | 50 Uds.

PERFILES ESQUINA

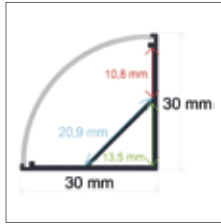

PERFIL DE ESQUINA CON EL DIFUSOR CURVO

Referencia	Medidas	P.V.P.
PL3030	30x30 mm. x 2 m.	34,81 €

Incluye difusor opal, 2 tapas y 4 grapas
Perfil de aluminio y difusor de PC

RoHS   40 Uds.

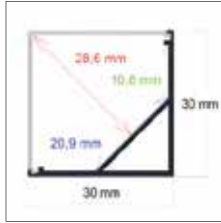

PERFIL DE ESQUINA CON EL DIFUSOR EN ÁNGULO RECTO

Referencia	Medidas	P.V.P.
PL3031	30x30 mm. x 2 m.	37,45 €

Incluye difusor opal, 2 tapas y 4 grapas
Perfil de aluminio y difusor de PC

RoHS   30 Uds.



PERFILES CILÍNDRICOS



PERFIL CILÍNDRICO

Referencia	Medidas	P.V.P.
PL420	Ø 20,4 mm. x 2 m.	37,06 €

Incluye difusor opal y 2 tapas
 Perfil de aluminio y difusor de PC
 Accesorios: PL5024

RoHS | 40 Uds.



PERFIL CILÍNDRICO

Referencia	Medidas	P.V.P.
PL430	Ø 30 mm. x 2 m.	29,11 €

Incluye difusor opal y 2 tapas
 Perfil de aluminio y difusor de PC
 Accesorios: PL5001, PL5000, PL5013, PL5005,
 PL5007, PL5008, PL5009

RoHS | 50 Uds.

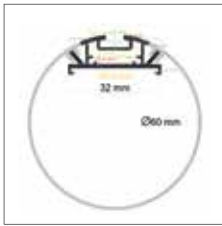

PERFIL CILÍNDRICO

Referencia	Medidas	P.V.P.
PL460	Ø 60 mm. x 2 m.	75,43 €

Incluye difusor opal y 2 tapas
 Perfil de aluminio y difusor de PC
 Accesorios: PL5001, PL5000, PL5013, PL5005,
 PL5007, PL5008, PL5009

RoHS | 25 Uds.



PERFIL CILÍNDRICO EXTRAGRANDE

Referencia	Medidas	P.V.P.
PL4120	Ø 120 mm. x 2 m.	161,27 €

Incluye difusor opal y 2 tapas
 Perfil de aluminio y difusor de PC
 Accesorios: PL5001, PL5000, PL5013, PL5005,
 PL5007, PL5008, PL5009

RoHS | 25 Uds.

PERFILES MUEBLES



PERFIL PARA MUEBLES ESPECIALMENTE DE COCINA

Referencia	Medidas	P.V.P.
PL2610	26x10,4 mm. x 2 m.	24,61 €

Incluye difusor opal y 2 tapas
Perfil de aluminio y difusor de PC

RoHS 50 Uds.

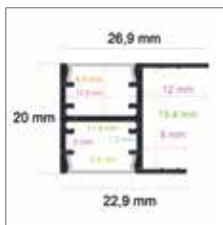

PERFIL PARA MUEBLES CON ILUMINACIÓN BIDIRECCIONAL

Referencia	Medidas	P.V.P.
PL2620	26,9x20 mm. x 2 m.	28,84 €

Incluye 2 difusores opal
No incluye tapas
Perfil de aluminio y difusores de PC

RoHS 50 Uds.



PERFIL PARA MUEBLES

Referencia	Medidas	P.V.P.
PL3112	31,15x11,8 mm. x 2 m.	27,78 €

Incluye difusor opal
Perfil de aluminio y difusor de PC

RoHS 50 Uds.

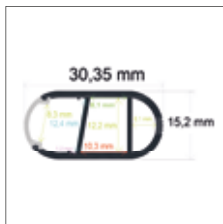

PERFIL PARA EL INTERIOR DE ARMARIOS

Referencia	Medidas	P.V.P.
PL3013	40,85x84,5 mm. x 2 m.	35,20 €

Incluye difusor opal
Perfil de aluminio y difusor de PC
Accesorios: PL5019, PL5020

RoHS 40 Uds.

PERFILES SUELO



PERFIL EMPOTRABLE EN EL SUELO DE INTERIORES

Referencia	Medidas	P.V.P.
PL1609	15,94x8,55 mm. x 2 m.	17,73 €

Incluye difusor opal, 2 tapas y 4 grapas
Perfil de aluminio y difusor de PC

RoHS | 100 Uds.



PERFIL EMPOTRABLE EN EL SUELO DE INTERIORES

Referencia	Medidas	P.V.P.
PL1613	16x12,55 mm. x 2 m.	19,31 €

Incluye difusor opal, 2 tapas y 4 grapas
Perfil de aluminio y difusor de PC

RoHS | 100 Uds.

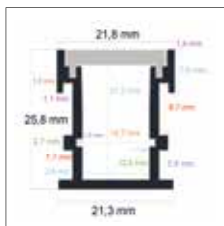

PERFIL EMPOTRABLE EN EL SUELO DE EXTERIORES

Referencia	Medidas	P.V.P.
PL2226	21,8x25,8 mm. x 2 m.	49,48 €

Incluye difusor opal y 2 tapas
Perfil de aluminio y difusor de PC
Accesorio: PL01111

RoHS | 30 Uds.

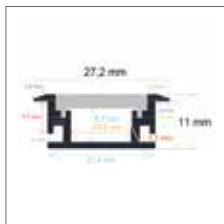

PERFIL EMPOTRABLE EN EL SUELO DE EXTERIORES

Referencia	Medidas	P.V.P.
PL2711	27,2x11 mm. x 2 m.	33,87 €

Incluye difusor opal y 2 tapas
Perfil de aluminio y difusor de PC
Accesorio: PL01111

RoHS | 50 Uds.

PERFILES ESCALERAS



PERFIL PARA ESCALERAS

Referencia	Medidas	P.V.P.
PL6826	68x26 mm. x 2 m.	71,45 €

Incluye difusor opal y 2 tapas
Perfil de aluminio y difusor de PC

RoHS CE |  20 Uds.



PERFIL PARA ESCALERAS

Referencia	Medidas	P.V.P.
PL6628	66,32x26,97 mm. x 2 m.	68,81 €

Incluye difusor opal y 2 tapas
Perfil de aluminio y difusor de PC

RoHS CE |  25 Uds.



PERFILES ARQUITECTÓNICOS

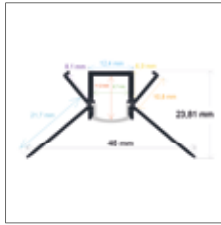

PERFIL PARA EMPOTRAR EN UNA ESQUINA

Referencia	Medidas	P.V.P.
PL4624	46x23,81 mm. x 2 m.	36,78 €

Incluye difusor opal y 2 tapas
 Perfil de aluminio y difusor de PC
 Accesorios: PL01101, PL01102

RoHS 50 Uds.

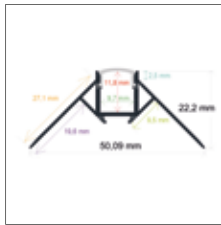

PERFIL PARA EMPOTRAR EN UNA ESQUINA

Referencia	Medidas	P.V.P.
PL5022	50,09x22,2 mm. x 2 m.	37,70 €

Incluye difusor opal y 2 tapas
 Perfil de aluminio y difusor de PC
 Accesorios: PL01101, PL01102

RoHS 50 Uds.

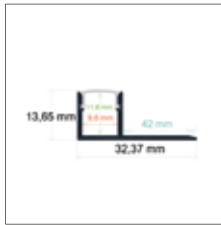

PERFIL PARA SER EMPOTRADO

Referencia	Medidas	P.V.P.
PL3213	32,37x13,65 mm. x 2 m.	27,26 €

Incluye difusor opal y 2 tapas
 Perfil de aluminio y difusor de PC
 Accesorios: PL01101, PL01102

RoHS 50 Uds.

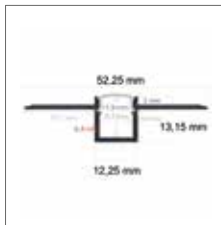

PERFIL PARA SER EMPOTRADO

Referencia	Medidas	P.V.P.
PL5213	52,25x13,15 mm. x 2 m.	35,20 €

Incluye difusor opal y 2 tapas
 Perfil de aluminio y difusor de PC
 Accesorios: PL01101, PL01102

RoHS 50 Uds.



PERFIL PARA EMPOTRAR EN UNA ESQUINA

Referencia	Medidas	P.V.P.
PL5424	53,5x23,82 mm. x 2 m.	36,39 €

Incluye difusor opal y 2 tapas
 Perfil de aluminio y difusor de PC
 Accesorios: PL01121, PL01122, PL01123, PL01124, PL01125, PL01126, PL01127

RoHS 50 Uds.

PERFILES ARQUITECTÓNICOS

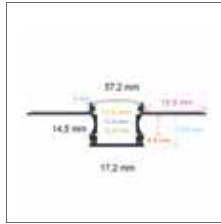

PERFIL PARA SER EMPOTRADO

Referencia	Medidas	P.V.P.
PL5815	57,2x14,5 mm. x 2 m.	33,87 €

Incluye difusor opal y 2 tapas
 Perfil de aluminio y difusor de PC

RoHS | 50 Uds.

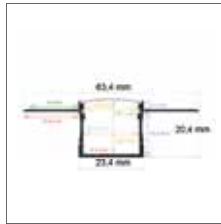

PERFIL PARA SER EMPOTRADO

Referencia	Medidas	P.V.P.
PL6320	63,4x20,4 mm. x 2 m.	40,76 €

Incluye difusor opal y 2 tapas
 Perfil de aluminio y difusor de PC

RoHS | 32 Uds.



PERFIL PARA SER EMPOTRADO O COLGADO

Referencia	Medidas	P.V.P.
PL7435	75x35 mm. x 2 m.	76,76 €

Incluye difusor opal y 2 tapas
 Perfil de aluminio y difusor de PC
 Accesorios: PL5001, PL5000, PL5013, PL5002,
 PL5003, PL5005, PL5007, PL5008, PL5009

RoHS | 20 Uds.

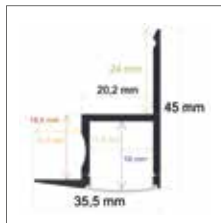

PERFIL PARA SER EMPOTRADO

Referencia	Medidas	P.V.P.
PL3545	35,5x45 mm. x 2 m.	52,93 €

Incluye difusor opal y 2 tapas
 Perfil de aluminio y difusor de PC

RoHS | 25 Uds.



PERFIL PARA EMPOTRAR

Referencia	Medidas	P.V.P.
PL6214	61,45x14,97 mm. x 2 m.	36,39 €

Incluye difusor opal y 2 tapas
 Perfil de aluminio y difusor de PC

RoHS | 50 Uds.

PERFILES COLGABLES



PERFIL DE SUPERFICIE CON OPCIÓN COLGANTE

Referencia	Medidas	P.V.P.
PL2327	23,2x26,7 mm. x 2 m.	41,56 €

Incluye difusor opal y 2 tapas
 Perfil de aluminio y difusor de PC
 Accesorios: PL5000, PL5001, PL5013, PL5002, PL5005, PL5007, PL5008, PL5009, PL01211, PL01212

RoHS 30 Uds.

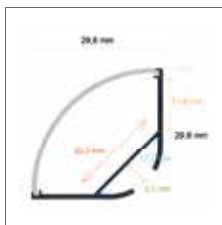

PERFIL COLGANTE CON EL DIFUSOR CURVO

Referencia	Medidas	P.V.P.
PL2929	29,8x29,8 mm. x 2 m.	29,11 €

Incluye difusor opal, 2 tapas y 4 grapas
 Perfil de aluminio y difusor de PC
 Accesorios: PL5001, PL5000, PL5013, PL5005, PL5007

RoHS 50 Uds.



PERFIL COLGANTE CON EL DIFUSOR EN ÁNGULO RECTO

Referencia	Medidas	P.V.P.
PL2930	29,8x29,8 mm. x 2 m.	30,43 €

Incluye difusor opal, 2 tapas y 4 grapas
 Perfil de aluminio y difusor de PC
 Accesorios: PL5001, PL5000, PL5013, PL5005, PL5007

RoHS 30 Uds.

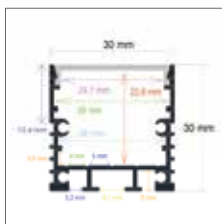

PERFIL DE SUPERFICIE CON OPCIÓN COLGANTE

Referencia	Medidas	P.V.P.
PL3032	30x30 mm. x 2 m.	50,28 €

Incluye difusor opal y 2 tapas
 Perfil de aluminio y difusor de PC
 Accesorios: PL5000, PL5001, PL5013, PL5002, PL5005, PL5007, PL5008, PL5009, PL5023, PL01281, PL01282

RoHS 25 Uds.



PERFIL DE SUPERFICIE CON OPCIÓN COLGANTE

Referencia	Medidas	P.V.P.
PL3535	35x35 mm. x 2 m.	66,15 €
PL35351	BLANCO - 35x35 mm. x 2 m.	72,78 €
PL35352	NEGRO - 35x35 mm. x 2 m.	72,78 €

Incluye difusor opal y 2 tapas Perfil de aluminio y difusor de PC
 Accesorios: PL01321, PL01322, PL5000, PL5001, PL5013, PL5002, PL5005, PL5007, PL5008, PL5009

RoHS 25 Uds.

PERFILES COLGABLES

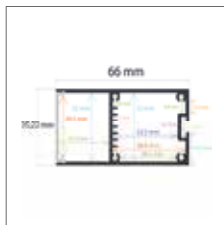

PERFIL COLGANTE

Referencia	Medidas	P.V.P.
PL3566	35,22x66 mm. x 2 m.	103,21 €

Incluye difusor opal y 2 tapas

Perfil de aluminio y difusor de PC

Accesorios: PL5000, PL5001, PL5013, PL5002, PL5011, PL5005, PL5007, PL5008, PL5009

RoHS | 10 Uds.

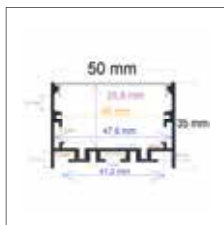

PERFIL DE SUPERFICIE CON OPCIÓN COLGANTE

Referencia	Medidas	P.V.P.
PL5034	50x35 mm. x 2 m.	79,40 €
PL50341	BLANCO - 50x35 mm. x 2 m.	86,01 €
PL50342	NEGRO - 50x35 mm. x 2 m.	86,01 €

Incluye difusor opal y 2 tapas. Perfil de aluminio y difusor de PC

Accesorios: PL5001, PL5000, PL5013, PL5002, PL5003, PL5011, PL5005, PL5007, PL5010, PL5008, PL5009, PL5018, PL01421, PL01422

RoHS | 18 Uds.

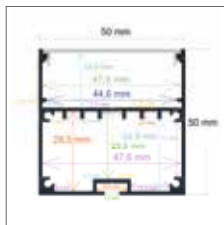

PERFIL COLGANTE

Referencia	Medidas	P.V.P.
PL5050	50x35 mm. x 2 m.	102,55 €

Incluye difusor opal y 2 tapas

Perfil de aluminio y difusor de PC

Accesorios: PL5001, PL5000, PL5013, PL5002, PL5005, PL5007, PL5002, PL5011, PL5008, PL5009

RoHS | 10 Uds.

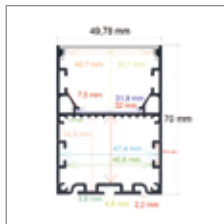

PERFIL DE SUPERFICIE CON OPCIÓN COLGANTE

Referencia	Medidas	P.V.P.
PL5070	49,78x70 mm. x 2 m.	130,26 €

Incluye difusor opal y 2 tapas

Perfil de aluminio y difusor de PC

Accesorios: PL5000, PL5001, PL5013, PL5002, PL5005, PL5007, PL5008, PL5009, PL01421, PL01422

RoHS | 10 Uds.



PERFIL COLGANTE CON ILUMINACIÓN BIDIRECCIONAL

Referencia	Medidas	P.V.P.
PL5074	50,18x75 mm. x 2 m.	131,49 €

Incluye 2 difusores opal y 2 tapas Perfil de aluminio y difusores de PC

Accesorios: PL5001, PL5000, PL5013, PL5005, PL5007, PL5008, PL5009

RoHS | 10 Uds.

PERFILES COLGABLES



PERFIL DE SUPERFICIE CON OPCIÓN COLGANTE

Referencia	Medidas	P.V.P.
PL5075	50x75 mm. x 2 m.	137,69 €

Incluye difusor opal y 2 tapas
 Perfil de aluminio y difusor de PC
 Accesorios: PL5000, PL5001, PL5013, PL5018, PL5005, PL5007, PL5008, PL5009, PL01421, PL01422

RoHS | 10 Uds.



PERFIL DE SUPERFICIE CON OPCIÓN COLGANTE

Referencia	Medidas	P.V.P.
PL5532	55x32 mm. x 2 m.	95,27 €

Incluye difusor opal y 2 tapas
 Perfil de aluminio y difusor de PC
 Accesorios: PL5001, PL5000, PL5013, PL5005, PL5007, PL5008, PL5009, PL01451, PL01452

RoHS | 15 Uds.

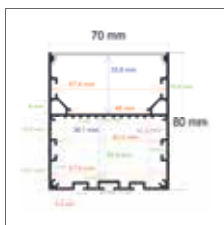

PERFIL COLGANTE

Referencia	Medidas	P.V.P.
PL7080	70x80 mm. x 2 m.	161,27 €

Incluye difusor opal y 2 tapas
 Perfil de aluminio y difusor de PC
 Accesorios: PL5001, PL5000, PL5013, PL5005, PL5007, PL5008, PL5009

RoHS | 8 Uds.

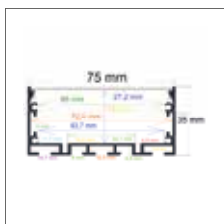

PERFIL COLGANTE

Referencia	Medidas	P.V.P.
PL7532	75x35 mm. x 2 m.	115,79 €

Incluye difusor opal y 2 tapas
 Perfil de aluminio y difusor de PC
 Accesorios: PL5000, PL5001, PL5013, PL5002, PL5011, PL5005, PL5007, PL5008, PL5009

RoHS | 12 Uds.

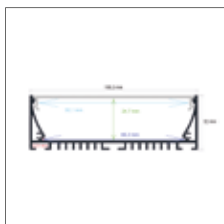

PERFIL DE SUPERFICIE CON OPCIÓN COLGANTE

Referencia	Medidas	P.V.P.
PL10032	100,2x32 mm. x 2 m.	132,73 €

Incluye difusor opal y 2 tapas Perfil de aluminio y difusor de PC
 Accesorios: PL5001, PL5000, PL5013, PL5002, PL5003, PL5005, PL5007, PL5008, PL5009

RoHS | 8 Uds.

PERFILES COLGABLES



PERFIL COLGANTE

Referencia	Medidas	P.V.P.
PL10070	100x70 mm. x 2 m.	182,35 €

Incluye difusor opal y 2 tapas
 Perfil de aluminio y difusor de PC
 Accesorios: PL5001, PL5000, PL5013, PL5002, PL5003, PL5011, PL5005, PL5007, PL5010, PL5008, PL5009

RoHS 8 Uds.

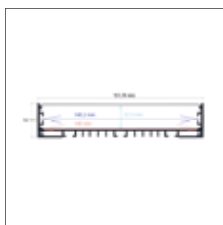

PERFIL DE SUPERFICIE CON OPCIÓN COLGANTE

Referencia	Medidas	P.V.P.
PL15032	151,76x32 mm. x 2 m.	210,89 €

Incluye difusor opal y 2 tapas
 Perfil de aluminio y difusor de PC
 Accesorios: PL5001, PL5000, PL5013, PL5002, PL5003, PL5005, PL5007, PL5008, PL5009

RoHS 6 Uds.

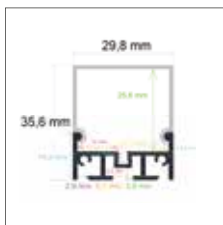

PERFIL DE SUPERFICIE CON OPCIÓN COLGANTE

Referencia	Medidas	P.V.P.
PL3036	29,8x35,6 mm. x 2 m.	51,09 €

Incluye difusor opal y 2 tapas
 Perfil de aluminio y difusor de PC
 Accesorios: PL5001, PL5000, PL5013, PL5005, PL5007, PL5002, PL5008, PL5009

RoHS 25 Uds.

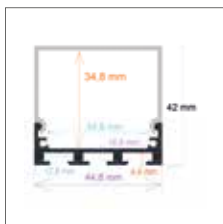

PERFIL DE SUPERFICIE CON OPCIÓN COLGANTE

Referencia	Medidas	P.V.P.
PL4542	44,8x42 mm. x 2 m.	76,67 €

Incluye difusor opal y 2 tapas
 Perfil de aluminio y difusor de PC
 Accesorios: PL5000, PL5001, PL5013, PL5002, PL5003, PL5005, PL5007, PL5008, PL5009

RoHS 20 Uds.



PERFIL DE SUPERFICIE CON OPCIÓN COLGANTE

Referencia	Medidas	P.V.P.
PL8075	80x75,2 mm. x 2 m.	136,47 €

Incluye difusor opal y 2 tapas Perfil de aluminio y difusor de PC
 Accesorios: PL5001, PL5000, PL5013, PL5002, PL5007, PL5008, PL5009

RoHS 10 Uds.

PERFILES EMPOTRABLES

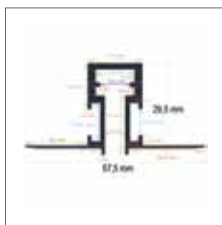

PERFIL PARA SER EMPOTRADO

Referencia	Medidas	P.V.P.
PL5830	57,5x29,5 mm. x 1 m.	80,64 €

Perfil de aluminio

Resultado indispensable usarlo junto a PL0619 y PL5005
Accesorios: PL0619, PL5005, PL5007, PL5008, PL5009

RoHS CE |  30 Uds.



PERFIL PARA SER EMPOTRADO

Referencia	Medidas	P.V.P.
PL1312	13x12 mm. x 2 m.	10,98 €

Incluye difusor opal y 2 tapa

Perfil de aluminio y difusor de PCs

RoHS CE |  125 Uds.



PERFILES EMPOTRABLES



PERFIL PARA SER EMPOTRADO

Referencia	Medidas	P.V.P.
PL1510	15x10,4 mm. x 2 m.	11,39 €

Incluye difusor opal y 2 tapas
Perfil de aluminio y difusor de PC

RoHS | 150 Uds.

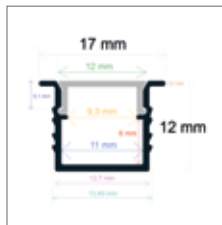
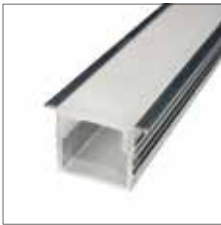

PERFIL PARA SER EMPOTRADO

Referencia	Medidas	P.V.P.
PL1712	17x12 mm. x 2 m.	13,23 €

Incluye difusor opal y 2 tapas
Perfil de aluminio y difusor de PC

RoHS | 100 Uds.



PERFIL PARA SER EMPOTRADO

Referencia	Medidas	P.V.P.
PL2314	23x14,5 mm. x 2 m.	17,03 €
PL23141	BLANCO - 23x14,5 mm. x 2 m.	18,12 €
PL23142	NEGRO - 23x14,5 mm. x 2 m.	18,12 €

Incluye difusor opal y 2 tapas
Perfil de aluminio y difusor de PC
Accesorios: PL01121, PL01122, PL01123, PL01124,
PL01125, PL01126, PL01127

RoHS | 50 Uds.



PERFIL PARA SER EMPOTRADO

Referencia	Medidas	P.V.P.
PL2407	23,2x7 mm. x 2 m.	9,22 €
PL24071	BLANCO - 23,2x7 mm. x 2 m.	10,18 €
PL24072	NEGRO - 23,2x7 mm. x 2 m.	10,18 €

Incluye difusor opal y 2 tapas
Perfil de aluminio y difusor de PC

RoHS | 100 Uds.

PERFILES EMPOTRABLES



PERFIL PARA SER EMPOTRADO

Referencia	Medidas	P.V.P.
PL2508	23x7,8 mm. x 2 m.	12,12 €
PL25081	BLANCO - 23x7,8 mm. x 2 m.	13,62 €
PL25082	NEGRO - 23x7,8 mm. x 2 m.	13,62 €

Incluye difusor opal y 2 tapas. Perfil de aluminio y difusor de PC
 Accesorios: PL01121, PL01122, PL01123, PL01124,
 PL01125, PL01126, PL01127

RoHS | 100 Uds.

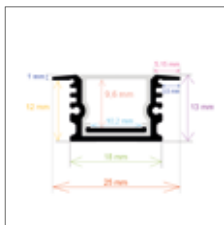

PERFIL PARA SER EMPOTRADO

Referencia	Medidas	P.V.P.
PL2513	25x13 mm. x 2 m.	29,11 €

Incluye difusor opal y 2 tapas
 Perfil de aluminio y difusor de PC

RoHS | 50 Uds.



PERFIL PARA SER EMPOTRADO

Referencia	Medidas	P.V.P.
PL3010	30,6x9,6 mm. x 2 m.	19,84 €

Incluye difusor opal y 2 tapas
 Perfil de aluminio y difusor de PC
 Accesorios: PL01211, PL01212, PL5016

RoHS | 50 Uds.



PERFIL PARA SER EMPOTRADO

Referencia	Medidas	P.V.P.
PL3020	30x20,4 mm. x 2 m.	27,78 €

Incluye difusor opal y 2 tapas
 Perfil de aluminio y difusor de PC
 Accesorios: PL01211, PL01212, PL5016

RoHS | 50 Uds.



PERFIL PARA SER EMPOTRADO

Referencia	Medidas	P.V.P.
PL3627	36,1x27,27 mm. x 2 m.	46,70 €

Incluye difusor opal y 2 tapas.
 Perfil de aluminio y difusor de PC
 Accesorios: PL01211, PL01212, PL5002, PL5007,
 PL5008, PL5009

RoHS | 30 Uds.

PERFILES EMPOTRABLES

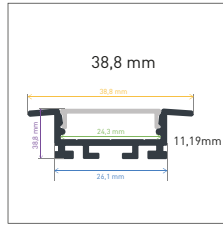

PERFIL PARA SER EMPOTRADO

Referencia	Medidas	P.V.P.
PL3912	38x11 mm. x 2 m.	26,47 €

Perfil de aluminio

Accesorios recomendados:

Difusor de 30 m. opal: PL01250

RoHS | 50 Uds.



PERFIL PARA SER EMPOTRADO

Referencia	Medidas	P.V.P.
PL4435	44,1x35 mm. x 2 m.	58,22 €

Incluye difusor opal y 2 tapas

Perfil de aluminio y difusor de PC

Accesorios: PL50047

RoHS | 25 Uds.

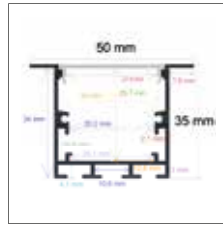

PERFIL PARA SER EMPOTRADO

Referencia	Medidas	P.V.P.
PL5035	50x35 mm. x 2 m.	61,53 €

Incluye difusor opal y 2 tapas

Perfil de aluminio y difusor de PC

Accesorios: PL01321, PL01322, PL5002, PL05003, PL5005, PL5007, PL5008, PL5009

RoHS | 20 Uds.

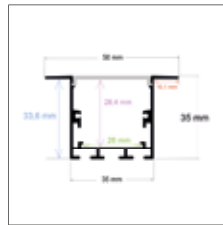

PERFIL PARA SER EMPOTRADO

Referencia	Medidas	P.V.P.
PL5635	56x35 mm. x 2 m.	63,51 €

Incluye difusor opal y 2 tapas

Perfil de aluminio y difusor de PC

Accesorios: PL5001, PL5000, PL5013, PL5003, PL5004, PL5017, PL5008, PL5009, PL5005, PL5007

RoHS | 20 Uds.



PERFIL PARA SER EMPOTRADO

Referencia	Medidas	P.V.P.
PL6535	64,8x35 mm. x 2 m.	78,90 €

Incluye difusor opal y 2 tapas

Perfil de aluminio y difusor de PC

Accesorios: PL01121, PL01122, PL01123, PL01124, PL01125, PL01126, PL01127

RoHS | 14 Uds.

PERFILES EMPOTRABLES

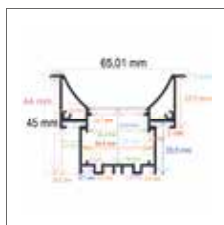

PERFIL PARA SER EMPOTRADO

Referencia	Medidas	P.V.P.
PL6545	65,01x45 mm. x 2 m.	83,11 €

Incluye difusor opal y 2 tapas
 Perfil de aluminio y difusor de PC
 Accesorios: PL5003, PL5005, PL5007, PL5008, PL5009

RoHS | 12 Uds.



PERFIL PARA SER EMPOTRADO

Referencia	Medidas	P.V.P.
PL7032	69,6x32 mm. x 2 m.	76,91 €

Incluye difusor opal y 2 tapas
 Perfil de aluminio y difusor de PC
 Accesorios: PL01451, PL01452, PL5004, PL5006, PL5012, PL5005, PL5007, PL5008, PL5009

RoHS | 15 Uds.

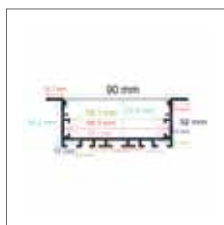

PERFIL PARA SER EMPOTRADO

Referencia	Medidas	P.V.P.
PL9032	90x32 mm. x 2 m.	111,65 €

Incluye difusor opal y 2 tapas
 Perfil de aluminio y difusor de PC
 Accesorios: PL5001, PL5000, PL5013, PL5004, PL5006, PL5012, PL5005, PL5007, PL5008, PL5009

RoHS | 10 Uds.



PERFIL PARA SER EMPOTRADO

Referencia	Medidas	P.V.P.
PL12535	125,15x35 mm. x 2 m.	158,80 €

Incluye difusor opal y 2 tapas
 Perfil de aluminio y difusor de PC
 Accesorios: PL5001, PL5000, PL5013, PL5003, PL5005, PL5007, PL5008, PL5009

RoHS | 6 Uds.



PERFIL CÓNCAVO CON ILUMINACIÓN BILATERAL INDIRECTA PARA EMPOTRAR

Referencia	Medidas	P.V.P.
PL10149	101,6x49,25 mm. x 2 m.	106,69 €

Incluye 2 difusores opal y 2 tapa
 Perfil de aluminio y difusores de PC
 Accesorios: PL5001, PL5000, PL5013, PL5017, PL5005, PL5008, PL5009

RoHS | 12 Uds.

PERFILES SUPERFICIE



PERFIL EXTRAFINO DE SUPERFICIE

Referencia	Medidas	P.V.P.
PL0619	6x19 mm. x 2 m.	30,43 €

Incluye difusor opal
 Perfil de aluminio y difusor de PC
 Accesorios: PL5830, PL5005

RoHS | 50 Uds.



PERFIL EXTRAFINO DE SUPERFICIE

Referencia	Medidas	P.V.P.
PL88	8x7,51 mm. x 2 m.	9,92 €

Incluye difusor opal, 2 tapas y 4 grapas
 Perfil de aluminio y difusor de PC

RoHS | 200 Uds.



PERFIL EXTRAFINO DE SUPERFICIE

Referencia	Medidas	P.V.P.
PL0809	7,8x9 mm. x 2 m.	9,66 €

Incluye difusor opal, 2 tapas y 4 grapas
 Perfil de aluminio y difusor de PC

RoHS | 250 Uds.

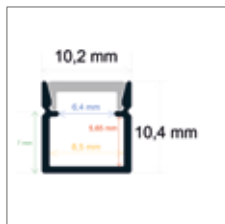

PERFIL DE SUPERFICIE

Referencia	Medidas	P.V.P.
PL1010	10,2x10,4 mm. x 2 m.	10,86 €

Incluye difusor opal, 2 tapas y 4 grapa
 Perfil de aluminio y difusor de PC

RoHS | 150 Uds.



PERFIL DE SUPERFICIE

Referencia	Medidas	P.V.P.
PL128	12,2x7,61 mm. x 2 m.	11,91 €

Incluye difusor opal, 2 tapas y 4 grapas
 Perfil de aluminio y difusor de PC

RoHS | 150 Uds.

PERFILES SUPERFICIE



PERFIL DE SUPERFICIE

Referencia	Medidas	P.V.P.
PL1013	10x13 mm. x 2 m.	13,89 €

Incluye difusor opal, 2 tapas y 4 grapas
Perfil de aluminio y difusor de PC

RoHS | 100 Uds.

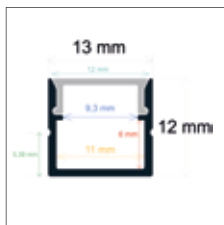

PERFIL DE SUPERFICIE

Referencia	Medidas	P.V.P.
PL1311	13x12 mm. x 2 m.	12,70 €

Incluye difusor opal, 2 tapas y 4 grapas
Perfil de aluminio y difusor de PC

RoHS | 100 Uds.

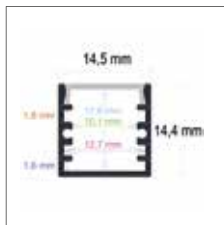

PERFIL DE SUPERFICIE

Referencia	Medidas	P.V.P.
PL1414	14,5x14,4 mm. x 2 m.	16,94 €

Incluye difusor opal, 2 tapas y 4 grapas
Perfil de aluminio y difusor de PC

RoHS | 100 Uds.

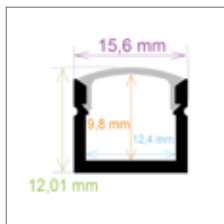

PERFIL DE SUPERFICIE

Referencia	Medidas	P.V.P.
PL1512	15,6x12,01 mm. x 2 m.	17,20 €

Incluye difusor opal, 2 tapas y 4 grapas
Perfil de aluminio y difusor de PC

RoHS | 100 Uds.

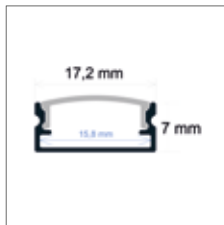

PERFIL DE SUPERFICIE

Referencia	Medidas	P.V.P.
PL1707	17,2x7 mm. x 2 m.	8,22 €
PL17071	BLANCO - 17,2x7 mm. x 2 m.	8,90 €
PL17072	NEGRO - 17,2x7 mm. x 2 m.	8,90 €

Incluye difusor opal, 2 tapas y 4 grapas
Perfil de aluminio y difusor de PC

RoHS | 100 Uds.

PERFILES SUPERFICIE



PERFIL DE SUPERFICIE

Referencia	Medidas	P.V.P.
PL1708	17x7,8 mm. x 2 m.	10,66 €
PL17081	BLANCO - 17x7,8 mm. x 2 m.	12,15 €
PL17082	NEGRO - 17x7,8 mm. x 2 m.	12,45 €

Incluye difusor opal, 2 tapas y 4 grapas

Perfil de aluminio y difusor de PC

Accesorios: PL5015, PL01121, PL01122, PL01123, PL01124, PL01125, PL01126, PL01127

RoHS 100 Uds.



PERFIL DE SUPERFICIE

Referencia	Medidas	P.V.P.
PL1714	17x14,5 mm. x 2 m.	16,31 €
PL17141	BLANCO - 17x14,5 mm. x 2 m.	16,52 €
PL17142	NEGRO - 17x14,5 mm. x 2 m.	16,52 €

Incluye difusor opal, 2 tapas y 4 grapas. Perfil de aluminio y difusor de PC

Accesorios: PL01121, PL01122, PL01123, PL01124, PL01125, PL01126, PL01127

RoHS 50 Uds.



PERFIL DE SUPERFICIE

Referencia	Medidas	P.V.P.
PL2015	20x15 mm. x 2 m.	24,48 €

Incluye difusor opal, 2 tapas y 4 grapas

Perfil de aluminio y difusor de PC

RoHS 50 Uds.



PERFIL DE SUPERFICIE CON OPCIÓN COLGANTE Y DIFUSOR CURVO

Referencia	Medidas	P.V.P.
PL1919	19,3x19,9 mm. x 2 m.	22,50 €

Incluye difusor opal y 2 tapas

Perfil de aluminio y difusor de PC

Accesorios: PL5001, PL5000, PL5013

RoHS 50 Uds.



PERFIL DE SUPERFICIE CON OPCIÓN COLGANTE Y DIFUSOR EN ÁNGULO RECTO

Referencia	Medidas	P.V.P.
PL1920	19,2x20,21 mm. x 2 m.	23,28 €

Incluye difusor opal y 2 tapas

Perfil de aluminio y difusor de PC

Accesorios: PL5001, PL5000, PL5013

RoHS 50 Uds.

PERFILES SUPERFICIE



PERFIL DE SUPERFICIE

Referencia	Medidas	P.V.P.
PL2020	20x19,7 mm. x 2 m.	27,78 €

Incluye difusor opal, 2 tapas y 4 grapas
Perfil de aluminio y difusor de PC

RoHS | 50 Uds.



PERFIL DE SUPERFICIE

Referencia	Medidas	P.V.P.
PL2310	23,4x9,7 mm. x 2 m.	19,19 €

Incluye difusor opal, 2 tapas y 4 grapas
Perfil de aluminio y difusor de PC
Accesorios: PL01211, PL01212, PL5016

RoHS | 100 Uds.



PERFIL DE SUPERFICIE

Referencia	Medidas	P.V.P.
PL2320	23,4x20,4 mm. x 2 m.	25,53 €

Incluye difusor opal, 2 tapas y 4 grapas
Perfil de aluminio y difusor de PC
Accesorios: PL01211, PL01212, PL5016

RoHS | 50 Uds.



PERFIL DE SUPERFICIE

Referencia	Medidas	P.V.P.
PL3011	30x10 mm. x 2 m.	27,00 €

Incluye difusor opal, 2 tapas y 4 grapas
Perfil de aluminio y difusor de PC
Accesorios: PL01281, PL01282

RoHS | 50 Uds.

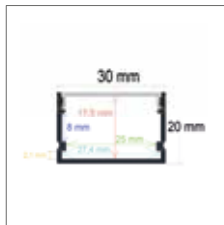

PERFIL DE SUPERFICIE

Referencia	Medidas	P.V.P.
PL3021	30x20 mm. x 2 m.	36,39 €

Incluye difusor opal, 2 tapas y 4 grapas
Perfil de aluminio y difusor de PC
Accesorios: PL01281, PL01282

RoHS | 40 Uds.

PERFILES SUPERFICIE

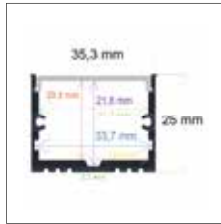

PERFIL DE SUPERFICIE

Referencia	Medidas	P.V.P.
PL3525	35,3x25 mm. x 2 m.	60,87 €

Incluye difusor opal y 2 tapas
Perfil de aluminio y difusor de PC

RoHS | 30 Uds.



PERFIL DE SUPERFICIE CON OPCIÓN COLGANTE

Referencia	Medidas	P.V.P.
PL3541	36,4x41,8 mm. x 2 m.	82,04 €

Incluye difusor opal y 2 tapas
Perfil de aluminio y difusor de PC
Accesorios: PL5000, PL5001, PL5013, PL560

RoHS | 19 Uds.



PERFIL DE SUP. CON ILUMINACIÓN LATERAL Y OPCIÓN COLGANTE

Referencia	Medidas	P.V.P.
PL4235	42,7x35 mm. x 2 m.	84,68 €

Incluye difusor opal y 2 tapas
Perfil de aluminio y difusor de PC
Accesorios: PL5000, PL5001, PL5013, PL560

RoHS | 20 Uds.



PERFIL DE SUPERFICIE

Referencia	Medidas	P.V.P.
PL1409	14x9 mm. x 2 m.	11,91 €

Incluye difusor opal, 2 tapas y 4 grapas
Perfil de aluminio y difusor de PC

RoHS | 100 Uds.



PERFIL DE SUPERFICIE

Referencia	Medidas	P.V.P.
PL1507	15x6,6 mm. x 2 m.	10,06 €

Incluye difusor opal, 2 tapas y 4 grapas
Perfil de aluminio y difusor de PC

RoHS | 150 Uds.

PERFILES SUPERFICIE

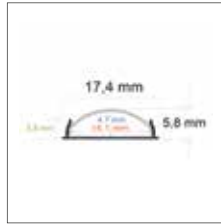

PERFIL FLEXIBLE DE SUPERFICIE

Referencia	Medidas	P.V.P.
------------	---------	--------

PL1806	17,4x5,8 mm. x 2 m.	10,33 €
--------	---------------------	---------

Incluye difusor opal, 2 tapas y 4 grapas
Perfil de aluminio y difusor de PC

RoHS | 200 Uds.



PERFIL DE SUPERFICIE

Referencia	Medidas	P.V.P.
------------	---------	--------

PL2507	24,77x7,4 mm. x 2 m.	20,25 €
--------	----------------------	---------

Incluye difusor opal, 2 tapas y 4 grapas
Perfil de aluminio y difusor de PC

RoHS | 80 Uds.



PERFIL DE SUPERFICIE

Referencia	Medidas	P.V.P.
------------	---------	--------

PL3909	38,98x8,77 mm. x 2 m.	27,78 €
--------	-----------------------	---------

Incluye difusor opal, 2 tapas y 4 grapas
Perfil de aluminio y difusor de PC

RoHS | 50 Uds.



PERFIL DE SUPERFICIE

Referencia	Medidas	P.V.P.
------------	---------	--------

PL5208	52,2x7,66 mm. x 2 m.	21,17 €
--------	----------------------	---------

Incluye difusor opal, 2 tapas y 4 grapas
Perfil de aluminio y difusor de PC

RoHS | 50 Uds.



PERFIL DE SUPERFICIE

Referencia	Medidas	P.V.P.
------------	---------	--------

PL5611	56x9,34 mm. x 2 m,	23,81 €
--------	--------------------	---------

Incluye difusor opal, 2 tapas y 4 grapas
Perfil de aluminio y difusor de PC

RoHS | 50 Uds.

PERFILES SENCILLOS



PERFIL DE SUPERFICIE

Referencia	Medidas	P.V.P.
------------	---------	--------

PL1503	15x2,5 mm. x 2 m.	10,06 €
--------	-------------------	---------

Perfil de aluminio

RoHS CE | 100 Uds.

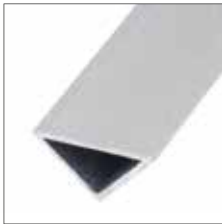

PERFIL TRIANGULAR

Referencia	Medidas	P.V.P.
------------	---------	--------

PL1508	14,57x7,4 mm. x 2 m.	6,61 €
--------	----------------------	--------

Perfil de aluminio

RoHS CE | 200 Uds.

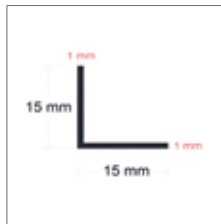
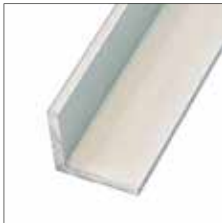

PERFIL DE SUPERFICIE

Referencia	Medidas	P.V.P.
------------	---------	--------

PL1515	15x15 mm. x 2 m.	13,89 €
--------	------------------	---------

Perfil de aluminio

Dos tapas por barra

Difusor opal de 2 m.

RoHS CE | 100 Uds.

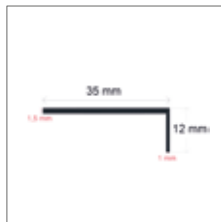

PERFIL DE SUPERFICIE

Referencia	Medidas	P.V.P.
------------	---------	--------

PL1235	16x16 mm. x 2 m.	15,89 €
--------	------------------	---------

Perfil de aluminio

Dos tapas por barra

Difusor opal de 2 m.

RoHS CE | 50 Uds.



PERFIL DE SUPERFICIE

Referencia	Medidas	P.V.P.
------------	---------	--------

PL1014	10x13,5 mm. x 2 m.	8,19 €
--------	--------------------	--------

Perfil de aluminio

RoHS CE | 150 Uds.

PERFILES FLEXIBLES PARA NEÓN



PERFIL FLEXIBLE PARA NEÓN

Referencia	Medidas	P.V.P.
PL30215	30x20 mm. x 2 m.	34,40 €

Incluye difusor de silicona, 2 tapas y 4 grapas
Perfil de aluminio

RoHS CE | 40 Uds.

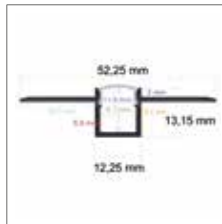

PERFIL FLEXIBLE PARA NEÓN

Referencia	Medidas	P.V.P.
PL52135	52,25x13,15 mm. x 2 m.	34,67 €

2 tapas. Perfil de aluminio
Accesorios: PL521351

RoHS CE | 50 Uds.



PERFIL FLEXIBLE PARA NEÓN

Referencia	Medidas	P.V.P.
PL58155	57,2x14,5 mm. x 2 m.	34,40 €

2 tapas. Perfil de aluminio

RoHS CE | 50 Uds.



MUESTRARIO DE PERFILES DE ALUMINIO

Referencia	P.V.P.
PL50-P203 Maletín con muestras	68,18 €

Muestrario con 114 modelos de perfiles y
15 modelos de difusores.

ACCESORIOS PARA PERFILES DIFUSORES ESPECIALES

MICROPRISMA

Rollos de 30 m.



ANCHO DE 12,5 MM.

Referencia	Color	P.V.P.
PL01120	Transparente	107,39 €

Difusor válido para el siguiente perfil:
PL5070, PL5034, PL6535, PL5075

RoHS 

ANCHO DE 25 MM.

Referencia	Color	P.V.P.
PL01250	Transparente	114,20 €

Difusor válido para el siguiente perfil:
PL3912

RoHS 

ANCHO DE 32 MM.

Referencia	Color	P.V.P.
PL01320	Transparente	184,09 €

Difusor válido para el siguiente perfil:
PL5035, PL3535

RoHS 

ANCHO DE 41 MM.

Referencia	Color	P.V.P.
PL01420	Transparente	264,20 €

Difusor válido para el siguiente perfil:
PL5070, PL5034, PL6535, PL5075

RoHS 

ANCHO DE 45 MM.

Referencia	Color	P.V.P.
PL01450	Transparente	286,36 €

Difusor válido para el siguiente perfil:
PL5532, PL7032

RoHS 

LUPA 60°

2 metros de largo.



Referencia	Color	P.V.P.
PL01128	Transparente	5,28 €

Perfiles de 12,5 mm.

Difusor válido para el siguiente perfil:
PL1818, PL1714

RoHS 

ACCESORIOS PARA PERFILES DIFUSORES

Rollo de 30 m.



Opal



Transparente

ANCHO DE 12 MM.

Referencia	Color	P.V.P.
PL01132	Opal	83,52 €

Difusor válido para el siguiente perfil:
PL7014

RoHS

ANCHO DE 21 MM.

Referencia	Color	P.V.P.
PL01211	Opal	97,16 €
PL01212	Transparente	97,16 €

Difusor válido para el siguiente perfil:
PL5070, PL5034, PL6535, PL5075

RoHS

ANCHO DE 28 MM.

Referencia	Color	P.V.P.
PL01281	Opal	131,25 €
PL01282	Transparente	131,25 €

Difusor válido para el siguiente perfil:
PL3011, PL3021, PL3032

RoHS

ANCHO DE 9,7 MM.

Referencia	Color	P.V.P.
PL01101	Opal	57,10 €
PL01102	Transparente	57,10 €

Difusor válido para el siguiente perfil:
PL4624, PL5022, PL3213, PL5213

RoHS

ANCHO DE 20 MM.

Referencia	Color	P.V.P.
PL01202	Opal	98,86 €

Difusor válido para el siguiente perfil:
PL2015

RoHS

ANCHO DE 21 MM. EN SUELO EXTERIORES

Referencia	Color	P.V.P.
PL01111	Opal	161,93 €

Difusor válido para los siguientes perfiles para el suelo de exteriores: PL2711, PL2226

RoHS

ANCHO DE 32 MM.

Referencia	Color	P.V.P.
PL01321	Opal	144,89 €
PL01322	Transparente	144,89 €

Difusor válido para el siguiente perfil:
PL5035, PL3535

RoHS

ACCESORIOS PARA PERFILES DIFUSORES/COLORES

ANCHO DE 41 MM.

Referencia	Color	P.V.P.
PL01421	Opal	187,50 €
PL01422	Transparente	187,50 €

Difusor válido para el siguiente perfil:
PL5070, PL5034, PL6535, PL5075

RoHS 

ANCHO DE 45 MM.

Referencia	Color	P.V.P.
PL01451	Opal	211,36 €
PL01452	Transparente	211,36 €

Difusor válido para el siguiente perfil:
PL5532, PL7032

RoHS 

DIFUSORES DE COLORES

Referencia	Color	P.V.P.
PL01121	Opal	75,00 €
PL01122	Transparente	75,00 €
PL01123	Negro	184,09 €
PL01124	Rojo	184,09 €
PL01125	Naranja	184,09 €
PL01126	Azul	184,09 €
PL01127	Verde	184,09 €

Difusor válido para el siguiente perfil:
PL1708, PL1714, PL2314, PL2508, PL4913,
PL4213, PL10149, PL5424, PL5815, PL7060

RoHS 

Rollos de 30 m.



PL01121



PL01122



PL01123



PL01124



PL01125



PL01126



PL01127

ACCESORIOS PARA PERFILES CONECTAR/COLGAR



PL5005



PL5007



PL5010



PL5008



PL5009



PL5014



PL5015



PL5001, PL5000, PL5013



PL5024

CONECTORES

Referencia	Producto	
PL5005	Conector para unión de perfiles en línea recta	3,76 €
PL5007	Conector para unión de perfiles en línea recta	2,05 €
PL5010	Conector para unión de perfiles en línea recta	1,88 €
PL5008	Conector plano de esquina para unir perfiles	2,47 €
PL5009	Conector de esquina en forma de "L" para unir perfiles	3,07 €
PL5014	Conector de esquina para unir barras del perfil PL1615	1,70 €
PL5015	Conector de esquina para unir barras del perfil PL1708	1,70 €

APLIQUES DE SUSPENSIÓN

Referencia	Producto	
PL5001*	Aplique de suspensión para colgar perfiles, con el cable de acero de 1 metro	8,78 €
PL5000*	Aplique de suspensión para colgar perfiles, con el cable de acero de 2 metros	10,99 €
PL5013*	Aplique de suspensión para colgar perfiles, con el cable de acero de 3 metros	12,36 €
PL5024*	Aplique de suspensión para colgar el perfil PL420, con el cable de acero de 1 m.	9,20 €

*Cada referencia incluye dos unidades

ACCESORIOS PARA PERFILES PINZAS/MUEBLES



PL5002



PL5003



PL5004



PL5006



PL5011



PL5012



PL5016



PL5017



PL5018, PL5021, PL5023



PL5019



PL5020

PINZAS Y GRAPAS

Referencia	Producto	
PL5002	Pinza para instalar gran variedad de perfiles	2,81 €
PL5003	Pinza para instalar gran variedad de perfiles	1,11 €
PL5004	Grapa para atornillar. Válida para: PL4435, PL5635, PL7032, PL9032	2,73 €
PL5006	Pinza para instalar los perfiles PL7032 y PL9032	2,39 €
PL5011	Pinza para empotrar: PL3566, PL5034, PL5050, PL7080, PL7532, PL10070	4,86 €
PL5012	Pinza para instalar los perfiles PL7032 y PL9032	2,39 €
PL5016	Soporte para los perfiles PL2310, PL2320, PL3010, PL3020	1,88 €
PL5017	Pinza para instalación de PL5635, PL7435, PL5035	7,41 €
PL5018	Grapa de sujeción para PL5034, PL5075, PL8075	0,94 €
PL5021	Grapa de sujeción para PL3535	0,94 €
PL5023	Grapa de sujeción para PL3032	0,94 €

ACCESORIOS DE PERFILES LED PARA MUEBLES

Referencia	Producto	
PL5019	Tapa lateral para el perfil de armarios PL3013	1,02 €
PL5020	Sujeción para el perfil de armarios PL3013	2,81 €

14.

SOLAR
SOLAR

SERIES ALUMINIUM SOLAR FLOOD LIGHT



DIMENSIONES DIMENSIONS

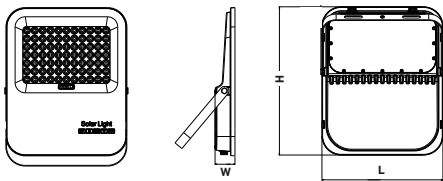

ACABADOS FINISHES



FOTOMETRÍA PHOTOMETRY

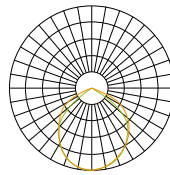

REGULACIÓN DIMMING

SERIES ALUMINIUM SOLAR FLOOD LIGHT

REF.	LÚMENES	CCT	BATERIA	VOLTAGE	ANG.	mAh	IP	P.V.P.
036950	600	5000K	LifeP04	3,2V	120°	5000	65	35,79 €
036967	1200	5000K	LifeP04	3,2V	120°	10000	65	52,52 €
036974	2200	5000K	LifeP04	3,2V	120°	20000	65	84,27 €
036981	3300	5000K	LifeP04	3,2V	120°	30000	65	110,24 €

MEDIDAS/MEASURES

REF.	LxHxW (mm)
036950	151x181x44
036967	187x224x44
036974	224x275x44
036981	270x331x44

INFORMACIÓN PANEL SOLAR/SOLAR PANEL INFO

REF.	POW.	VOLTAGE	DIMENSIONES (mm)	MATERIAL
036950	6W	5V	210*200*17	POLICRISTALINO
036967	10W	5V	205*300*17	POLICRISTALINO
036974	20W	5V	390*300*17	POLICRISTALINO
036981	30W	5V	390*400*17	POLICRISTALINO

SERIES INTEGRATED SOLAR STREET LIGHT



Al 50.000h IP 65 RATED IK08 \triangle 90° -20°+40° CRI <70  RoHS COMPLIANT CE 3 AÑOS GARANTIA

DIMENSIONES DIMENSIONS

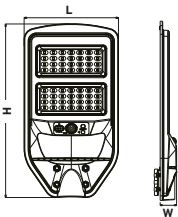

ACABADOS FINISHES



FOTOMETRÍA PHOTOMETRY

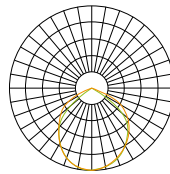

REGULACIÓN DIMMING

SERIES INTEGRATED SOLAR STREET LIGHT

REF.	LÚMENES	CCT	BATERIA	VOLTAGE	ANG.	mAh	IP	P.V.P.
036905	600	5000K	LifeP04	3,2V	120°	4000	65	27,13 €
036912	1300	5000K	LifeP04	3,2V	120°	8000	65	38,10 €
036929	1950	5000K	LifeP04	3,2V	120°	12000	65	49,07 €
036936	2350	5000K	LifeP04	3,2V	120°	15000	65	58,30 €

MEDIDAS/MEASURES

REF.	LxHxW (mm)
036905	216x219x46
036912	231x413x47
036929	231x511x47
036936	251x622x47

INFORMACIÓN PANEL SOLAR/SOLAR PANEL INFO

REF.	POW.	VOLTAGE	DIMENSIONES (mm)	MATERIAL
036905	5W	5V	213.8*210.5, glass 2.0mm,	POLICRISTALINO
036912	8W	5V	211*299, glass 2.0mm,	POLICRISTALINO
036929	12W	5V	211*397, glass 3.0mm,	POLICRISTALINO
036936	15W	5V	231*508, glass 3.0mm,	POLICRISTALINO

ACCESORIOS/ACCESSORIES

REF.	DESCRIPCIÓN	P.V.P.
036943	STREET LAMP POLE ø48mm 380mm	6,49 €

SERIES INTEGRATED SOLAR STREET LIGHT



DIMENSIONES DIMENSIONS

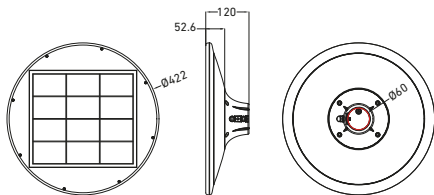

ACABADOS FINISHES



FOTOMETRÍA PHOTOMETRY

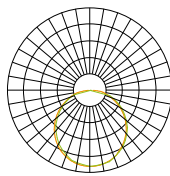

REGULACIÓN DIMMING

DIMMABLE

SERIES INTEGRATED SOLAR STREET LIGHT

REF.	LÚMENES	CCT	BATERIA	VOLTAGE	ANG.	mAh	IP	P.V.P.
039135	2300	3000K 4000K 5700K	LifeP04	3,2V	360°	15000	65	98,89 €

INFORMACIÓN PANEL SOLAR/SOLAR PANEL INFO

REF.	POW.	VOLTAGE	DIMENSIONES (mm)	MATERIAL
39135	15W	6V	29,5*26,5mm	MONOCRISTALINO

SERIES LED SOLAR WALL LIGHT



DIMENSIONES DIMENSIONS

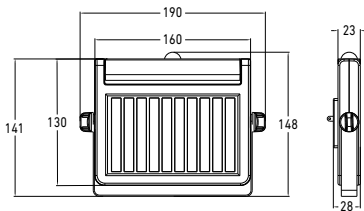

ACABADOS FINISHES



FOTOMETRÍA PHOTOMETRY

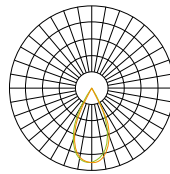

REGULACIÓN DIMMING

SERIES LED SOLAR WALL LIGHT

REF.	LÚMENES	3CCT	BATERIA	VOLTAGE	ANG.	mAh	IP	P.V.P.
036998	500	3000K	LifeP04	3,2V	60°	1800	54	16,71 €

INFORMACIÓN PANEL SOLAR/SOLAR PANEL INFO

REF.	POW.	VOLTAGE	DIMENSIONES (mm)	MATERIAL
036998	1,8W	5V	138*84*2mm	MONOCRISTALINO

15.

INDUSTRIAL
INDUSTRIAL

SERIES UFO MAX - ALTO RENDIMIENTO





190 LM/W

AL AC 100 277V ⌚ 50.000h Hz 50/60 4.000°K 5.700°K IP 65 RATED  NO FLICKERING IK08  PF >0.95  L70 50.000h MACADAM <5 RoHS COMPLIANT CE

5 AÑOS GARANTÍA  LUMILEDS **PHILIPS**

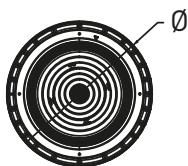
DIMENSIONES DIMENSIONS



ACABADOS FINISHES



FOTOMETRÍA PHOTOMETRY

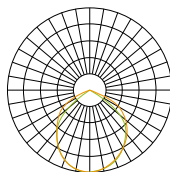

REGULACIÓN DIMMING

DALI

SERIES UFO MAX - ALTO RENDIMIENTO

REF.	POW.	LED	CCT	LM	ANG.	DRIVER	IP	P.V.P.
038466	100W	LUMILEDS	4000K	19000	120°	PHILIPS	65	132,11 €
038459	100W	LUMILEDS	5700K	19000	120°	PHILIPS	65	132,11 €
038480	150W	LUMILEDS	4000K	28500	120°	PHILIPS	65	147,67 €
038473	150W	LUMILEDS	5700K	28500	120°	PHILIPS	65	147,67 €
038503	200W	LUMILEDS	4000K	38000	120°	PHILIPS	65	165,44 €
038497	200W	LUMILEDS	5700K	38000	120°	PHILIPS	65	165,44 €

REGULACIONES/DIMMING

REF.	POW.	ACABADO	CCT	LM	ANG.	CRI	IP	P.V.P.
DALI								
38466-D	100W	LUMILEDS	4000K	19000	120°	PHILIPS	65	197,10 €
38459-D	100W	LUMILEDS	5700K	19000	120°	PHILIPS	65	197,10 €
38480-D	150W	LUMILEDS	4000K	28500	120°	PHILIPS	65	212,65 €
38473-D	150W	LUMILEDS	5700K	28500	120°	PHILIPS	65	212,65 €
38503-D	200W	LUMILEDS	4000K	38000	120°	PHILIPS	65	230,45 €
38497-D	200W	LUMILEDS	5700K	38000	120°	PHILIPS	65	230,45 €

ACCESORIOS/ACCESSORIES

REF.	DESCRIPCIÓN	P.V.P.
991226	SOPORTE PARA UFO MAX 100W	14,00 €
991227	SOPORTE PARA UFO MAX 150W	15,17
991224	SOPORTE PARA UFO MAX 200W	16,33

ÓPTICAS/OPTICS

REF.	DESCRIPCIÓN	P.V.P.
38982	LENTE PARA UFO MAX 150W 60°	7,25 €
38981	LENTE PARA UFO MAX 150W 90°	7,25 €
38980	LENTE PARA UFO MAX 200W 60°	8,64 €
38979	LENTE PARA UFO MAX 200W 90°	8,64 €

MEDIDAS/MEASURES

REF.	ØxH (mm)
038466	Ø260x165mm
038459	Ø260x165mm
038480	Ø300x177mm
038473	Ø300x177mm
038503	Ø340x184mm
038497	Ø340x184mm

SERIES UFO CCT MULTIPOWER



SELECTOR CCT

Sistema de selección de temperatura de color mediante interruptor. Posibilidad de seleccionar la temperatura deseada entre blanco cálido 3000K, blanco neutro 4000K y blanco frío 5000K.



SELECTOR DE POTENCIA

Sistema de selección de la potencia mediante un interruptor. Posibilidad de seleccionar la potencia deseada entre 100w, 150w y 200w.



50.000h



AC 100V 277V



IP 65 RATED



Hz 50/60



CRI >80



IK08



PF >0.95



110°



-20° +40°



CCT 3000K/4000K/5000K



S 2835



CE



RoHS COMPLIANT

5 AÑOS GARANTÍA



DIMENSIONES DIMENSIONS

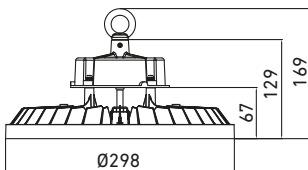

FOTOMETRÍA PHOTOMETRY

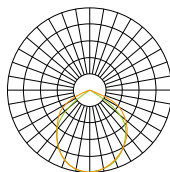

ACABADOS FINISHES



REGULACIÓN DIMMING

0-10V

SERIES UFO CCT MULTIPOWER

REF.	POW.	LED	CCT	LM	ANG.	DRIVER	IP	P.V.P.
037100	100W 150W 200W	LUMILEDS	3000K 4000K 5000K	16000 24000 32000	110°	PHILIPS	66	136,00 €

ACCESORIOS/ACCESSORIES

REF.	DESCRIPCIÓN	P.V.P.
038701	SOPORTE SUPERFICIE PARA UFO CCT	18,70 €
038886	SENSOR DE MICROONDAS	32,85 €
038909	BASE ZHAGA	5,65 €

ÓPTICAS/OPTICS

REF.	DESCRIPCIÓN	P.V.P.
038695	LENTE PARA UFO CCT 60°	8,12 €

SERIES UFO PRO



AI AC 90V 305V 50.000h Hz 50/60 4.000°K 5.700°K IP 65 RATED DIMMABLE NO FLICKERING 0-10V IK08 PF >0.95 L70 50.000h

MACADAM <5

RoHS COMPLIANT



5 AÑOS GARANTÍA



LUMILEDS

PHILIPS

DIMENSIONES DIMENSIONS

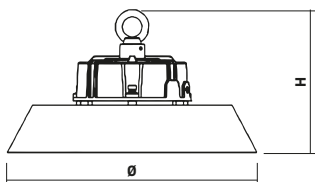

ACABADOS FINISHES



FOTOMETRÍA PHOTOMETRY

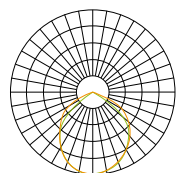

REGULACIÓN DIMMING

0-10V

SERIES UFO PRO

REF.	POW.	LED	CCT	LM	ANG.	DRIVER	IP	P.V.P.
E8-4451	100W	LUMILEDS	4000K	14000	120°	PHILIPS	65	128,10 €
E8-4468	100W	LUMILEDS	5700K	14000	120°	PHILIPS	65	128,10 €
E8-4475	150W	LUMILEDS	4000K	21000	120°	PHILIPS	65	150,15 €
E8-4482	150W	LUMILEDS	5700K	21000	120°	PHILIPS	65	150,15 €
E8-4499	200W	LUMILEDS	4000K	28000	120°	PHILIPS	65	175,56 €
E8-4505	200W	LUMILEDS	5700K	28000	120°	PHILIPS	65	175,56 €

ACCESORIOS/ACCESSORIES

REF.	DESCRIPCIÓN	P.V.P.
991226	SOPORTE SUPERFICIE PARA UFO PRO 100W	14,00 €
991227	SOPORTE SUPERFICIE PARA UFO PRO 150W	15,17 €
991224	SOPORTE SUPERFICIE PARA UFO PRO 200W	16,33 €

ÓPTICAS/OPTICS

REF.	DESCRIPCIÓN	P.V.P.
031870	LENTE PARA UFO PRO 100W 60°	5,84 €
031887	LENTE PARA UFO PRO 100W 90°	5,84 €
031894	LENTE PARA UFO PRO 150W 60°	6,53 €
031900	LENTE PARA UFO PRO 150W 90°	6,53 €
031917	LENTE PARA UFO PRO 200W 60°	7,78 €
031924	LENTE PARA UFO PRO 200W 90°	7,78 €

MEDIDAS/MEASURES

REF.	ØxH (mm)
E8-4451	Ø280x180mm
E8-4468	Ø280x180mm
E8-4475	Ø320x180mm
E8-4482	Ø320x180mm
E8-4499	Ø350x180mm
E8-4505	Ø350x180mm

SERIES PROYECTOR ECO CCT



SELECTOR CCT

Sistema de selección de temperatura de color mediante interruptor. Posibilidad de seleccionar la temperatura deseada entre blanco cálido 2700K, blanco neutro 4000K y blanco frío 6000K.



Al



2.700°K

4.000°K

6.000°K

AC

220V
240V



Hz

50/60

PF

>0.9

CRI

>80



NO DIMMABLE



IP 20
RATED



RoHS
COMPLIANT



CE



3 AÑOS
GARANTÍA

DIMENSIONES DIMENSIONS

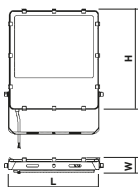

ACABADOS FINISHES



FOTOMETRÍA PHOTOMETRY

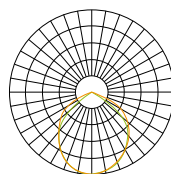

REGULACIÓN DIMMING

SERIES PROYECTOR ECO CCT

REF.	POW.	LED	CCT	LM	ANG.	DRIVER	IP	P.V.P.
042869	20W	SMD2835	2700K 4000K 6000K	1800	120°	IC	65	13,25 €
042876	30W	SMD2835	2700K 4000K 6000K	2700	120°	IC	65	16,75 €
042883	50W	SMD2835	2700K 4000K 6000K	4500	120°	IC	65	23,70 €
042890	100W	SMD2835	2700K 4000K 6000K	9000	120°	IC	65	44,95 €
042906	150W	SMD2835	2700K 4000K 6000K	13500	120°	IC	65	68,80 €
042913	200W	SMD2835	2700K 4000K 6000K	18000	120°	IC	65	95,75 €

MEDIDAS/MEASURES

REF.	LxHxW (mm)
042869	112*85*35
042876	135*110*35
042883	185*130*35
042890	280*200*35
042906	428*260x35
042913	486*305*35

SERIES PANTALLA ESTANCA



SELECTOR CCT

Sistema de selección de temperatura de color mediante interruptor. Posibilidad de seleccionar la temperatura deseada entre blanco cálido 3000K, blanco neutro 4000K y blanco frío 5000K.



50.000h

AC

220V
240V

IP 66
RATED

Hz
50/60

CRI
>80

IK08

PF
>0.90



120°

-10°+40°

CCT
3000K/4000K
5000K



RoHS
COMPLIANT

5 AÑOS
GARANTÍA

DIMENSIONES DIMENSIONS

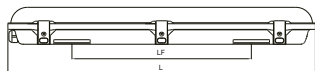

FOTOMETRÍA PHOTOMETRY

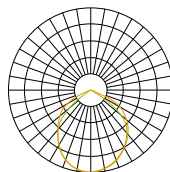

ACABADOS FINISHES



REGULACIÓN DIMMING

SERIES PANTALLA ESTANCA

REF.	POW.	LED	CCT	LM	ANG.	DRIVER	IP	P.V.P.
037469	20W	YLD	3000K 4000K 6000K	2300	120°	YLD	66	27,82 €
037476	40W	YLD	3000K 4000K 6000K	4600	120°	YLD	66	39,88 €
037483	60W	YLD	3000K 4000K 6000K	6900	120°	YLD	66	50,85 €

MEDIDAS/MEASURES

REF.	SIZE	L(mm)	W(mm)	H(mm)	LF(mm)
037469	2FT Twin	600	100	72	350
037476	4FT Twin	1200	100	72	780
037483	5FT Twin	1500	100	72	1080

16.

BOMBILLAS Y GU10
LED BULBS & GU10

GU10 DIMMABLE/ALUMINIO/ USO PROFESIONAL



DIMENSIONES DIMENSIONS

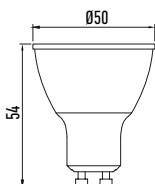

ACABADOS FINISHES



FOTOMETRÍA PHOTOMETRY

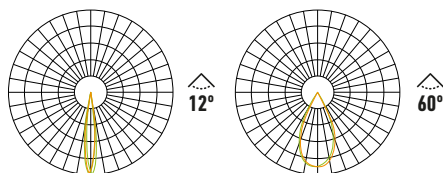

REGULACIÓN DIMMING

SERIES LC8104 DIMMABLE

REF.	POW.	CCT	LM	ANG.	P.V.P.
035335	6,5W	2700K	600	12°	12,59 €
035342	6,5W	3000K	600	12°	12,59 €
035359	6,5W	4000K	600	12°	12,59 €
035328	6,5W	2700K	600	60°	12,59 €
029259	6,5W	3000K	600	60°	12,59 €
029266	6,5W	4000K	600	60°	12,59 €

GU10 3CCT BOX



SELECTOR CCT

Sistema de selección de temperatura de color mediante interruptor. Posibilidad de seleccionar la temperatura deseada entre blanco cálido 3000K, blanco neutro 4000K y blanco frío 5700K.



9W

806
LUMEN



3.000°K 4.000°K 5.700°K

AC
220V
240V

Hz
50/60

120°

NO DIMMABLE

IP 20
RATED

CRI
>80

PF
>0.5

30.000h



RoHS
COMPLIANT

3 AÑOS
GARANTÍA

DIMENSIONES DIMENSIONS

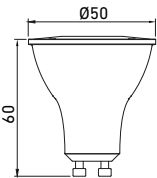

ACABADOS FINISHES



GU10 3CCT BOX

FOTOMETRÍA PHOTOMETRY

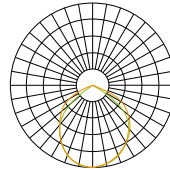

REGULACIÓN DIMMING

REF.	POW.	CCT	LM	ANG.	P.V.P.
039753	9W	3000K 4000K 5700k	806	120°	3,00 €

GU10 120° BOX



30.000h



ON/OFF
x 100.000



AC
220V
240V



Hz
50/60



NO DIMMABLE



IP 20
RATED

2.700°K

3.000°K

4.000°K

5.700°K



PF
>0.5



CRI
>80



SMD2835



RoHS
COMPLIANT

DIMENSIONES DIMENSIONS

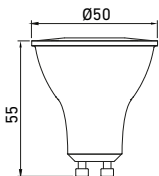

ACABADOS FINISHES



GU10 120° BOX

FOTOMETRÍA PHOTOMETRY

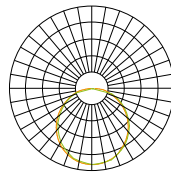

REGULACIÓN DIMMING

REF.	POW.	CCT	LM	ANG.	P.V.P.
039555	9W	2700K	820	120	1,90 €
039562	9W	3000K	820	120	1,90 €
039579	9W	4000K	820	120	1,90 €
039586	9W	5700K	820	120	1,90 €

GU10 38° BOX



25.000h



ON/OFF
x 100.000



AC
220V
240V



Hz
50/60



NO DIMMABLE



IP 20
RATED

2700K

3.000°K

4.000°K

6.000°K



38°



CRI
80



RoHS
COMPLIANT

DIMENSIONES DIMENSIONS

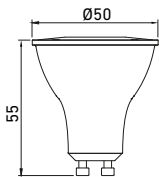

ACABADOS FINISHES



GU10 38° BOX

FOTOMETRÍA PHOTOMETRY

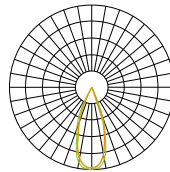

REGULACIÓN DIMMING

REF.	POW.	CCT	LM	ANG.	P.V.P.
039517	7W	2700K	560	38°	1,60 €
039524	7W	3000K	560	38°	1,60 €
039531	7W	4000K	560	38°	1,60 €
039548	7W	6000K	560	38°	1,60 €

ESFÉRICA G45 - E27



30.000h



ON/OFF
x100.000



AC
220V
240V



Hz
50/60



NO DIMMABLE



IP 20
RATED

2700K

3.000°K

4.000°K

5.700°K



PF
>0.5



CRI
>80



SMD2835



DIMENSIONES DIMENSIONS

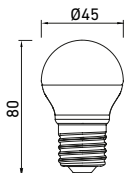

FOTOMETRÍA PHOTOMETRY

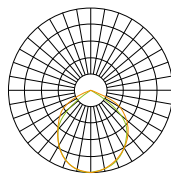

ACABADOS FINISHES



REGULACIÓN DIMMING

ESFÉRICA G45 - E27

REF.	POW.	CCT	LM	ANG.	P.V.P.
039593	9W	2700K	820	160	1,90 €
039609	9W	3000K	820	160	1,90 €
039616	9W	4000K	820	160	1,90 €
039623	9W	5700K	820	160	1,90 €

ESFÉRICA P45 - E14



DIMENSIONES DIMENSIONS

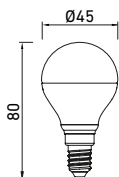

ACABADOS FINISHES



ESFÉRICA P45 - E14

FOTOMETRÍA PHOTOMETRY

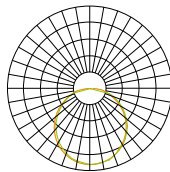

REGULACIÓN DIMMING

REF.	POW.	CCT	LM	ANG.	P.V.P.
039630	9W	2700K	820	160	1,90 €
039647	9W	3000K	820	160	1,90 €
039654	9W	4000K	820	160	1,90 €
039661	9W	5700K	820	160	1,90 €

ESTÁNDAR E27



DIMENSIONES DIMENSIONS

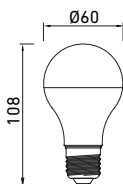

ACABADOS FINISHES



FOTOMETRÍA PHOTOMETRY

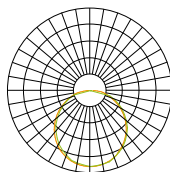

REGULACIÓN DIMMING

ESTÁNDAR E27

REF.	POW.	CCT	LM	ANG.	P.V.P.
039678	12W	2700K	1150	200	1,90 €
039685	12W	3000K	1150	200	1,90 €
039692	12W	4000K	1150	200	1,90 €
039708	12W	5700K	1150	200	1,90 €
039715	18W	2700K	1800	200	2,30 €
039722	18W	3000K	1800	200	2,30 €
039739	18W	4000K	1800	200	2,30 €
039746	18W	5700K	1800	200	2,30 €

CONDICIONES GENERALES DE VENTA

Todas las operaciones comerciales entre YLD y cualquiera de sus clientes implican la aceptación íntegra de las siguientes condiciones generales de venta, salvo condiciones particulares pactadas por ambas partes.

PRECIOS

En los pedidos sin condiciones especiales se aplicarán las tarifas vigentes en la fecha de recepción del pedido.

En los pedidos con condiciones especiales pactadas se aplicarán las condiciones acordadas y aceptadas por escrito entre las partes.

Para los pedidos a fábrica, con características especiales o bajo demanda será necesaria la aceptación por escrito por parte de YLD sobre precios, plazos, características y/o cualquier otra condición que afecte al pedido.

Las modificaciones a las condiciones aceptadas podrán suponer una revisión de las condiciones iniciales.

Las modificaciones o actualizaciones de las tarifas en vigor se comunicarán a los clientes activos con, al menos, un mes de antelación.

Las tarifas en vigor no contemplan ningún tipo de impuesto ni tasa adicional, aplicándose esta según normativa de cada país.

PEDIDOS

Los pedidos se considerarán recepcionados una vez estén completos todos los datos referentes a medidas, color, referencia, pvp etc

En caso de que el pedido o parte del mismo no pueda ser servido o se produzca algún tipo de retraso YLD informará al cliente de manera inmediata y procederá a actuar según las indicaciones del cliente ante tal inconveniente.

Los pedidos con precios erróneos o condiciones no pactadas serán retenidos por YLD, quien contactará con el cliente para las aclaraciones necesarias y no se tramitarán hasta recibir confirmación escrita por parte del cliente.

Los pedidos que requieran de un plazo de entrega específico deberán ser validados por YLD y comunicados al cliente. En caso de no recibir comunicación por parte del cliente sobre dichos plazos YLD no será responsable por cualquier tipo de retraso.

DEVOLUCIONES O ANULACION DE PEDIDOS

Para cualquier tipo de anulación o devolución será necesaria la aceptación por parte de YLD, no admitiéndose ningún tipo de devolución no aceptada.

Los productos con características especiales o bajo demanda no podrán ser devueltos ni anulados los pedidos en ningún caso.

No se aceptarán devoluciones de productos que no estén en perfecto estado, incluido su embalaje.

En las devoluciones por causas ajenas a YLD los costes de envío correrán por cuenta del cliente. YLD se reserva el derecho de aplicar hasta un 20% de depreciación para las devoluciones en concepto de manipulación, revisión, etiquetado y documentación.

GARANTÍA

El fabricante garantiza el correcto funcionamiento del equipo y posibles reparaciones o suministro de recambios del modelo debidos a defectos de fabricación durante 3 años desde la fecha de entrega, pero no puede responsabilizarse de daños y/o perjuicios causados por un mal empleo de este. Para cualquier reclamación, se deberá adjuntar a esta garantía el ticket de compra. La empresa se compromete a la reparación total gratuita de los vicios o defectos originados y de los daños y perjuicios directamente ocasionados por ellos. Así mismo, si la reparación no es satisfactoria y el objeto no reviste las condiciones óptimas para cumplir el uso al que está destinado, el titular de la garantía tendrá derecho a la sustitución del objeto adquirido por otro de idénticas características o a la devolución del precio pagado.

NO INSTALE EL PRODUCTO SI ESTÁ DAÑADO. Esta luminaria se embolsó adecuadamente de modo tal que las piezas no resulten dañadas durante su transporte. Inspecciónela para confirmarlo. Nos reservamos el derecho a estudiar cada producto devuelto por especialistas, quedando la garantía exenta en caso de demostrar que la incidencia o fallo ha sido causado por el usuario, por problemas de la instalación o elementos ajenos al producto. Un representante del Fabricante tendrá acceso a los Productos defectuosos. El justificante de compra de los productos estará a disposición del Fabricante para su inspección. La presente garantía no cubre los gastos de mano de obra para el desmontaje de los Productos. Si el Fabricante opta por sustituir un Producto defectuoso, pero no puede hacerlo porque ya no se fabrica o no se encuentra disponible, el Fabricante puede devolver al comprador la cantidad abonada o sustituir el producto por otro equiparable (cuyo diseño o especificaciones pueden variar ligeramente). Esta garantía limitada sólo será válida cuando el Producto se haya conectado e instalado correctamente, y esté funcionando con los valores eléctricos, intervalo de funcionamiento y condiciones medioambientales previstas en las especificaciones, guías de aplicación, instrucciones, normas IEC o cualquier otro documento suministrado con los Productos. El FABRICANTE no se hace responsable de las

condiciones del suministro eléctrico, incluyendo los picos de tensión, las fluctuaciones de tensión los sistemas de control de ondulación de corriente que sobrepasen los límites especificados de los productos y los definidos en las normas de suministro pertinentes (por ejemplo, las normas EN 50160). La presente garantía no es válida para los daños o fallos de funcionamiento por causas de fuerza mayor o de cualquier tipo de uso incorrecto, uso indebido, uso anómalo o uso que infrinja las normas, códigos o instrucciones de uso correspondientes, incluyendo sin limitaciones los contenidos en las normativas en materia de seguridad, industria y/o electricidad más recientes y vigentes en las regiones pertinentes. El mantenimiento del producto deberá ser realizado según las instrucciones y por personal especializado únicamente. Se debe conservar un registro adecuado del historial de funcionamiento que estará a disposición del FABRICANTE para su inspección.

Si se determina que un Producto es defectuoso o no funciona de acuerdo con las especificaciones del producto, el Comprador debe notificarlo por escrito al FABRICANTE.

Todos los períodos de garantía mencionados están sujetos a que un representante del FABRICANTE pueda acceder al producto o sistema defectuoso para comprobar la no conformidad. Las reclamaciones de garantía deben notificarse y enviarse a la oficina regional del FABRICANTE en un plazo de 30 días a partir de la identificación, y se debe especificar la siguiente información como mínimo (puede pedirse información adicional):

- Productos defectuosos. Para las garantías del Sistema, también se deben especificar otros componentes que se utilicen.

- Fecha de instalación y fecha de factura.

- Descripción detallada del problema y la cantidad y % de fallos, código de fecha del fallo.

- Aplicación, horas de funcionamiento y ciclos de conmutación.

- Cuando la reclamación de garantía esté justificada, el FABRICANTE correrá con los gastos de transporte. El FABRICANTE podrá facturar al Cliente los Productos devueltos que no sean defectuosos o no conformes conjuntamente con los gastos de transporte, comprobación y gestión asociados.

La presente Garantía no cubre:

- Exposición a ambientes corrosivos o gases agresivos de origen químico.

- Uso negligente, impropio o inadecuado.

- Uso del producto a una temperatura ambiente distinta a la especificada.

- En fuentes de luz LED, fallos inferiores al 0,2% por cada 1000h.

- Pérdida de flujo lumínico inferior al 30% en fuentes de luz LED.

- Humedad relativa en la instalación por encima de 80%, o exceder las condiciones según el grado IP del producto para el cual fue diseñado.

- Luminarias cerradas, con menos de 10mm de aire alrededor del cuerpo del producto

CALIDAD

Todos nuestros productos están sometidos a rigurosos controles de calidad y en nuestro continuo proceso de evolución y mejora estos pueden sufrir algún tipo de modificación, ampliación o retirada del catálogo sin previo aviso. Estos cambios en ningún caso serán motivo de reclamación por parte del comprador.

CERTIFICADOS

Todos los productos YLD cumplen con las normativas y directivas Europeas CE y ROHS. Además, y según gama, con certificaciones TÜV, SAFETY REPORT Y CE VOLUNTARY ASSESMENT emitidos por laboratorios independientes.

TRANSPORTE

Tal y como marca la ley los envíos se consideran realizados una vez sean entregados a la agencia de transportes, siendo los riesgos del mismo por cuenta del comprador. YLD colaborará activamente en la resolución de cualquier incidencia con los envíos. YLD no se responsabilizará de cualquier incidencia en el transporte y/o entrega en envíos gestionados por el cliente. Los riesgos referidos a cualquier incidencia en las devoluciones correrán siempre por cuenta del comprador. Los envíos internacionales serán gestionados y correrán siempre por cuenta del comprador, excepción hecha de los acuerdos especiales y documentados por escrito.

RESERVA DE PROPIEDAD

YLD se reserva el derecho de propiedad de todos sus materiales hasta que el comprador haya hecho efectivo el pago total de los mismos, incluso frente a terceros.

DERECHOS DE PATENTE E IMAGEN

Todos los productos YLD están protegidos por la ley sobre los derechos de imagen, patentes y marcas. Queda expresamente prohibido el re-embalado o distribución de los mismos con imagen diferente a la original YLD. Queda expresamente prohibida la comercialización de productos YLD con otras marcas o nombre diferentes a los originales YLD, incluso en comercio ON LINE.

JURISDICCION

Ante cualquier discrepancia o litigio que se derive de las presentes condiciones generales de venta ambas partes se someterán a la competencia de juzgados y tribunales de Madrid, con expresa renuncia a su fuero propio.

GENERAL SALES CONDITIONS

These General Sales Conditions shall be applicable between YLD Lighting Manufacturer S.A. (hereinafter 'YLD') and Purchaser, unless otherwise agreed by written agreement between the Parties.

PRICES

In orders without special conditions, the price list in force shall be applied at the time of reception of the order. In orders with special conditions, they shall be applied prior consent in writing of both parties. For custom manufacturing orders or those with special requirements, the acceptance in writing of prices, terms, specifications and/or any other condition which could affect the order shall be necessary. Any amendment to the agreed conditions could imply a revision of the initial conditions. Amendments or updates in the price list in force shall be communicated to active customers at least at one month in advance. Price lists in force do not cover any kind of additional tax or fee; these shall be applied regarding the current regulation in every country.

ORDERS

Orders shall be deemed to be received once they are complete with all details about size, power, colour, code, price, etc. In case that the full order or a part of it cannot be supplied or any kind of delay occurs, YLD shall inform the Purchaser immediately, and act according to instructions given by the Purchaser. Orders with wrong prices or non-agreed conditions shall be withheld by YLD, who will contact the customer to get the necessary clarifications, and shall not be issued until obtaining written confirmation from the customer. Orders which require a specific delivery term shall be validated by YLD, and the customer shall be informed. If no reply from the customer is received regarding the term, YLD shall not be responsible for any kind of delay.

RETURN OF PRODUCTS OR CANCELLATION OF ORDERS

Any kind of cancellation of orders or return of products shall require the approval of YLD, not being admitted any return which has not been previously accepted. In no case shall products and orders on demand or with special features be returned nor cancelled or exchanged.

No return of products shall be accepted unless they are in perfect condition, including the packages. For returns due to reasons beyond YLD's control, the shipping costs shall be borne by the customer. In case of return, YLD reserves the right to apply a depreciation of up to a 20% for handling, checking, labelling and documentation expenses.

WARRANTY

All our products have a warranty term, which depends on their range.

- 3 years for lighting fixtures and trims, bulbs, tubes, downlights and lamps

- 3 years for technical lighting items

*Possibility of extending the warranty up to 5 years, prior acceptance of the particular conditions of this extent. The

warranty shall cover any manufacturing defect, remaining exempt from any failure or damage caused by an improper use or handling, a short-circuit, voltage peaks, etc. Damages caused by external factors such as fire, water, electric storms, extreme temperatures, falls, bumps or depletion of the lifespan of the product shall also remain exempt from warranty. The YLD technical department shall be the sole responsible of determining the reason for using the warranty, likewise reserving the right to repair or replace the affected item. It shall be mandatory to show the purchase document and the item to be replaced or repaired.

QUALITY

All our products are submitted to strict quality controls and, in our continuous process of evolution and improvement, they can undergo some changes or be removed from catalogue without prior advisory. In no case shall the customer be entitled to claim for this reason.

CERTIFICATES

All YLD products fulfil the CE and ROHS directives and European regulations. Furthermore, and depending on the range, they have TÜV, SAFETY REPORT AND CE VOLUNTARY ASSESSMENT certificates, issued by independent laboratories.

TRANSPORT

As law states, shipments shall be deemed to be made once the goods are delivered to the forwarder, and it shall be the customer who bear the risks associated to that shipments. YLD shall collaborate actively in the resolution of any dispute related to shipments. YLD shall not be responsible of any incidence in transport and/or delivery of shipments managed by the Purchaser. Risks associated to any incidence in returns of products shall always at the Purchaser's expense. International shipments shall always be managed and borne by the Purchaser, except in case of special agreements documented in writing.

RESERVATION OF OWNERSHIP

YLD reserves the ownership of all its materials until the Purchaser has fully made the payment, even for third parties.

PATENT AND IMAGE RIGHTS

All YLD products are protected by the law on patents, image rights and trademarks. It is strictly forbidden the repackaging or distribution of the aforementioned products with a different image from the original. It is strictly forbidden to commercialize YLD products with trademarks or names different from the originals, including in the online trading.

ARBITRATION

In case of dispute arising from the present general sales conditions, both parties shall submit to the jurisdiction of the courts of Madrid, expressly waiving to their own jurisdiction.



YLD LIGHTING MANUFACTURER S.A.

Delegación Central EUROPA

Avda. del Olivar 14-16 Pol. Ind. La Postura

28343 Valdemoro (Madrid) **ESPAÑA**

+34 911 123 853

info@yld-eu.com

www.yld-eu.com